

Water- and Environment-resistive FA Connectors Save Wiring and Maintenance Effort



- Compact FA connectors meet IP67 requirements and ensure a 94V-0 fire retardant rating.
- A wide array of connectors makes a wiring system more modular, simplifies maintenance, and reduces downtime.
- Connectors with Cables and Connector Assemblies are available.
- Three types of Connector Assembly: Crimping, soldering, and screw-on.
- Connectors with Cables are UL certified.
- Based on IEC61076-2-101 (IEC60947-5-2) and NECA 4202.



Refer to Safety Precautions on page 34.

For the most recent information on models that have been certified for safety standards, refer to your OMRON website.

Model Number Legend

Connectors with Cables Model Number Legend

Connector	Cable specifications	XS2: M12 Screw Connection			XS5: One-touch Smartclick Connection* (compatible with M12 connectors)			
		Cable length (m)	Model	Reference page	Cable length (m)	Model		
Connectors on both cable ends	Fire-retardant, PVC robot cable	0.5	XS2W-D421-B81-F	5	0.5	XS5W-D421-B81-F		
		1	XS2W-D421-C81-F		1	XS5W-D421-C81-F		
		2	XS2W-D421-D81-F		2	XS5W-D421-D81-F		
		3	XS2W-D421-E81-F		3	XS5W-D421-E81-F		
		4	XS2W-D421-F81-F		4	XS5W-D421-F81-F		
		5	XS2W-D421-G81-F		5	XS5W-D421-G81-F		
		10	XS2W-D421-J81-F		10	XS5W-D421-J81-F		
		15	XS2W-D421-K81-F		15	XS5W-D421-K81-F		
	Spatter-resistant cable	2	XS2W-D421-D81-SA	2	XS5W-D421-D81-SA			
		5	XS2W-D421-G81-SA	5	XS5W-D421-G81-SA			
		Connector on one cable end (Socket)	Fire-retardant, PVC robot cable	1	XS2F-D421-C80-F	7	1	XS5F-D421-C80-F
				2	XS2F-D421-D80-F		2	XS5F-D421-D80-F
				3	XS2F-D421-E80-F		3	XS5F-D421-E80-F
				5	XS2F-D421-G80-F		5	XS5F-D421-G80-F
10	XS2F-D421-J80-F			10	XS5F-D421-J80-F			
15	XS2F-D421-K80-F			15	XS5F-D421-K80-F			
20	XS2F-D421-L80-F		20	XS5F-D421-L80-F				
Spatter-resistant cable	2	XS2F-D421-D80-SA	2	XS5F-D421-D80-SA				
	5	XS2F-D421-G80-SA	5	XS5F-D421-G80-SA				
	Connector on one cable end (Plug)	Fire-retardant, PVC robot cable	0.3	XS2H-D421-A80-F	14	0.3	XS5H-D421-A80-F	
			0.5	XS2H-D421-B80-F		0.5	XS5H-D421-B80-F	
			1	XS2H-D421-C80-F		1	XS5H-D421-C80-F	
2			XS2H-D421-D80-F	2		XS5H-D421-D80-F		
3			—	3		XS5H-D421-E80-F		
5			XS2H-D421-G80-F	5		XS5H-D421-G80-F		
Spatter-resistant cable		0.3	XS2H-D421-A80-SA	0.3		XS5H-D421-A80-SA		
		1	XS2H-D421-C80-SA	1		XS5H-D421-C80-SA		

*For details, refer to the data sheet of the XS5 Round Water-resistant Connectors (M12 Smartclick).
 Note 1. Only DC, straight, 4-core types, and common cable specifications are shown above. Refer to the relevant pages for other products.
 2. Other than the M12 sizes introduced above, M8-sized (XS3) products are also available.
 For details, refer to the data sheet of the XS3 Round Water-resistant Connectors (M8/S8).

XS2: M12 Screw Connection

XS5: One-touch Smartclick Connection* (compatible with M12 screws)

Note: Screw connections will be made if connecting with a screw type.



*For details, refer to the data sheet of the XS5 Round Water-resistant Connectors (M12 Smartclick).

Ratings and Specifications

Rated current	4 A
Rated voltage	250 VAC/VDC
Contact resistance (Connector)	40 mΩ max. (20 m V max. and 100 mA max.)
Insulation resistance	1,000 MΩ min. (at 500 VDC)
Dielectric strength (Connector)	1,500 VAC for 1 min (leakage current: 1 mA max.)
Degree of protection	IP67 (IEC60529)
Insertion tolerance	200 times
Cable holding strength	Cable diameter: 6 mm 98 N/15 s 4 to 5 mm 49 N/15 s 3 mm 29 N/15 s
Ambient operating temperature range	-25 to 70°C *
Ambient humidity range	20% to 85%

*Use the robot cable within a temperature range between 0°C and 70°C to prevent the wires inside the cable from being broken when bending it.

Materials and Finish

Item	Model	XS2F/H/W	XS2F-LED	XS2M/R/P	XS2C/G
Contacts		Copper alloy/Gold plating		Brass	
Thread bracket		Copper alloy/Nickel plated *			
Pin block		PBT resin		PA resin	PBT resin
O-ring		Rubber			
Cover		PBT resin	TPU resin	—	PBT resin
Cable	Fire-retardant, PVC robot cable	UL AWM2464 CL3, 6 mm dia. AWG20 Sheath color: light gray	—	—	—
	Non-polar DC Connectors with Standard PVC cable	6 mm dia. AWG20 Sheath color: light gray	—	—	—
	E2E models with conventional connector pin with Fire-retardant, PVC robot cable	UL AWM2464 CL3, 6 mm dia. AWG20 Sheath color: light gray	—	—	—
	Standard PVC cable up to 105°C	6 mm dia. AWG20 Sheath color: light gray	—	—	—
	Spatter-resistant cable	6.6 mm dia. AWG20 Sheath color: blue	—	—	—
	Standard PVC cable (XS2F-LED)	—	UL AWM2464 5.0 mm dia. (3 conductors) 5.4 mm dia. (4 conductors) 0.34 mm ² Sheath color: black	—	—

*The T-joint of the XS2R is aluminum/white.

Pin Arrangement (Engaged Side)

Item	No. of poles	4 poles	5 poles
DC type	Male (plug) contacts		
	Female (socket) contacts		
AC type	Male (plug) contacts		—
	Female (socket) contacts		—

Note: The AC and DC mating section forms are different as shown here and therefore cannot be connected together.

Connections

Connection Combinations

OMRON model No.		M12 Plug Connectors	Smartclick Plug Connectors
		XS2H, XS2G, XS2W (plug side), XS2R (plug side), XS2M	XS5H, XS5G, XS5W (plug side), XS5R (plug side), XS5M
M12 Socket Connectors	XS2F, XS2C, XS2W (socket side), XS2R (socket side), XS2P	○	○
Smartclick Socket Connectors	XS5F, XS5C, XS5W (socket side), XS5R (socket side), XS5P	○	⊗

⊗: Connected by twisting.

○: Connected by screwing.

Note: The XS□M and XS□P cannot mate with each other.

XS2W Sockets and Plugs on Both Cable Ends

Model Number Structure

Model Number Legend

Use this model number legend to identify products from their model number. Use this model number legend to identify products from their model number. When ordering, use a model number from the table in *Ordering Information*.

XS2W-D **2** **1**

1
2
3
4
5
6
7
8
9

1. Type

W: Connectors with cables, socket and plug on both cable ends

2. AC/DC (Mating Section Form)

D: For DC

3. Connector Poles

4: 4 poles

5: 5 poles

4. Contact Plating

2: Gold plating

5. Cable Connection Direction

1: Straight (socket)/Straight (plug)

2: Right-angle (socket)/Right-angle (plug)

3: Straight (socket)/Right-angle (plug)

4: Right-angle (socket)/Straight (plug)

6. Cable Length

A : 0.3 m

B : 0.5 m

C : 1 m

D : 2 m

E : 3 m

F : 4 m

G : 5 m

H : 7 m

J : 10 m

K : 15 m

L : 20 m

7. Connections (Numbers inside circles are terminal numbers)

8 : ① Brown, ② White, ③ Blue, ④ Black (for DC)

G : ① Brown, ② White, ③ Blue, ④ Black, ⑤ Gray

8. Connectors on One End/Both Ends

1: Both ends

9. Cable Specifications

F : Fire-retardant, PVC robot cable

SA : Spatter-resistant cable

S : Standard PVC cable

XS2W Sockets and Plugs on Both Cable Ends

Ordering Information

Cable specifications	Cable connection direction	No. of cable cores	Cable diameter (mm)	Cable core cross-sectional area (mm ²)	Cable length L (m)	DC	UL	
						Model		
Fire-retardant, PVC robot cable	Straight (Plug)/ Straight (Socket)	4	6.0 dia.	0.5	0.5	XS2W-D421-B81-F	UL 2238 certified (File No. E207683)	
					1	XS2W-D421-C81-F		
					2	XS2W-D421-D81-F		
					3	XS2W-D421-E81-F		
					4	XS2W-D421-F81-F		
					5	XS2W-D421-G81-F		
					10	XS2W-D421-J81-F		
					15	XS2W-D421-K81-F		
					20	XS2W-D421-L81-F		
					Right-angle (Plug)/ Right-angle (Socket)	4		6.0 dia.
	5	XS2W-D422-G81-F						
	Straight (Socket)/ Right-angle (Plug)	2	XS2W-D423-D81-F					
		5	XS2W-D423-G81-F					
	Right-angle (Socket)/ Straight (Plug)	4	6.0 dia.	0.5	1	XS2W-D424-C81-F		
2					XS2W-D424-D81-F			
Standard Cable	Straight (Plug)/ Straight (Socket)	5	6.0 dia.	0.3	2	XS2W-D521-DG1-A	—	
					5	XS2W-D521-GG1-A		
Spatter-resistant cable	Straight (Plug)/ Straight (Socket)	4	6.6 dia.	0.5	2	XS2W-D421-D81-SA	—	
					5	XS2W-D421-G81-SA		

Note: Ask your OMRON representative about other cable lengths.

Dimensions

Straight (Socket)/Straight (Plug)
 Fire-retardant, PVC robot cable
 XS2W-D421-□81-F
 Spatter-resistant cable
 XS2W-D421-D81-SA
 Standard cable (5 cores)
 XS2W-D521-□G1-A

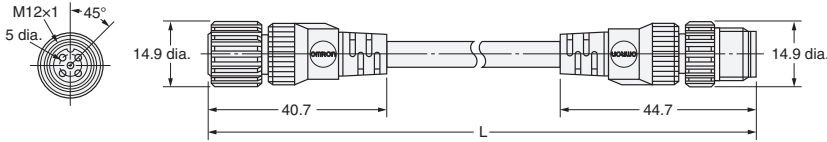

Right-angle/Right-angle
 Fire-retardant, PVC robot cable
 XS2W-D422-□81-F

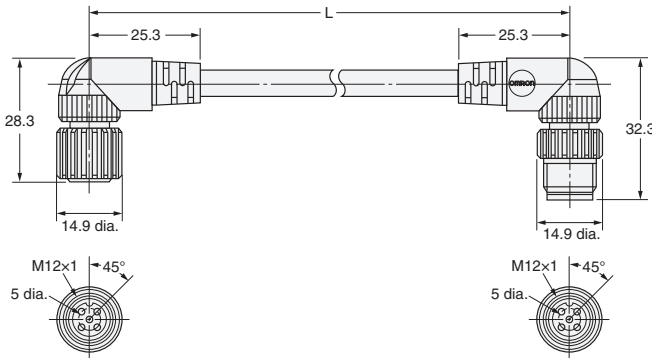

Wiring Diagram for 4 Cores

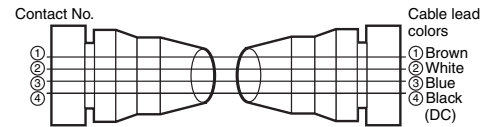

Straight (Socket)/Right-angle (Plug)
 Fire-retardant, PVC robot cable
 XS2W-D423-□81-F

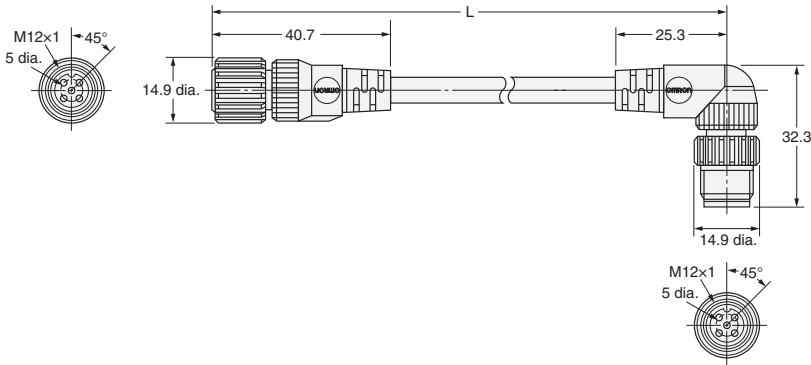

Wiring Diagram for 5 Cores

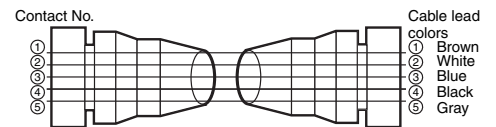

Right-angle (Socket)/Straight (Plug)
 Fire-retardant, PVC robot cable
 XS2W-D424-□81-F

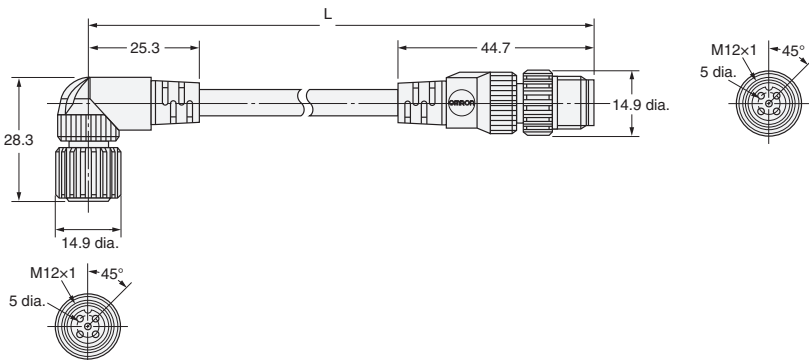

XS2F Socket on One Cable End

Model Number Structure

Model Number Legend

Use this model number legend to identify products from their model number. Use this model number legend to identify products from their model number. When ordering, use a model number from the table in *Ordering Information*.

XS2F- **2** - **0**-

1 2 3 4 5 6 7 8 9

1. Type

F: Connector with cables, socket on one cable end

2. AC/DC (Mating Section Form)

A: For AC

D: For DC

E: For DC, stainless steel lock

3. Connector Poles

4: 4 poles

5: 5 poles

4. Contact Plating

2: Gold plating

5. Cable Connection Direction

1: Straight

2: Right-angle

6. Cable Length

A : 0.3 m

B : 0.5 m

C : 1 m

D : 2 m

E : 3 m

F : 4 m

G : 5 m

H : 7 m

J : 10 m

K : 15 m

L : 20 m

Note: Only the 2 m (D), 5 m (G) and 10 m (J) cables are available for cables with 5 poles.

7. Connections

(Numbers inside circles are terminal numbers)

A : ① Brown, ② ---, ③ ---, ④ Blue (for DC)

B : ① ---, ② ---, ③ Brown, ④ Blue (for AC)

C : ① Brown, ② ---, ③ Blue, ④ Black

D : ① ---, ② ---, ③ Blue, ④ Brown

8 : ① Brown, ② White, ③ Blue, ④ Black (for DC)

9 : ① Brown, ② White, ③ Blue, ④ Black (for AC)

G : ① Brown, ② ---, ③ Blue, ④ Black, ⑤ Gray

8. Connectors on One End/Both Ends

0: One end

9. Cable Specifications

F: Fire-retardant, PVC robot cable

E: Heat-resistant cable up to 105°C

SA: Spatter-resistant cable

A: Standard PVC cable

Note: E type and SA type is a 4-core cable.

Designations for Non-polar DC
(For Limit Switches and Sensors)

6. Cable Length

3: 2 m

4: 5 m

7. Connections

(Numbers inside circles are terminal numbers)

1: ① ---, ② ---, ③ Black, ④ White

8. Connectors on One End/Both Ends

0: One end

9. Cable Specifications

Not designated.

Note: DC non-polarity models have different specific codes. (6, 7 and 9)

XS2F Socket on One Cable End

Ordering Information

Cable specifications	Cable connection direction	No. of cable cores	Cable diameter (mm)	Cable core cross-sectional area (mm ²)	Cable length L (m)	DC	AC	UL				
						Model	Model					
Fire-retardant, PVC robot cable	Straight	2	6.0 dia.	0.5	1	XS2F-D421-CA0-F	XS2F-A421-CB0-F	UL 2238 certified (File No. E207683)				
		3				XS2F-D421-CC0-F	—					
		4				XS2F-D421-C80-F	XS2F-A421-C90-F					
		2			2	XS2F-D421-DA0-F	XS2F-A421-DB0-F					
		3				XS2F-D421-DC0-F	—					
		4				XS2F-D421-D80-F	XS2F-A421-D90-F					
		4			3	XS2F-D421-E80-F	—					
		2			5	XS2F-D421-GA0-F	XS2F-A421-GB0-F					
		3				XS2F-D421-GC0-F	—					
		4				XS2F-D421-G80-F	XS2F-A421-G90-F					
		2			10	XS2F-D421-JA0-F	XS2F-A421-JB0-F					
		3				XS2F-D421-JC0-F	—					
		4				XS2F-D421-J80-F	XS2F-A421-J90-F					
		15			15	XS2F-D421-K80-F	—					
	20	20			XS2F-D421-L80-F	—						
	Right-angle	2			2	6.0 dia.	0.5		1	XS2F-D422-CA0-F	XS2F-A422-CB0-F	
					3					XS2F-D422-CC0-F	—	
					4					XS2F-D422-C80-F	—	
					2				2	XS2F-D422-DA0-F	XS2F-A422-DB0-F	
		3			XS2F-D422-DC0-F					—		
		4			XS2F-D422-D80-F					—		
		4			3				XS2F-D422-E80-F	—		
		2			5				XS2F-D422-GA0-F	XS2F-A422-GB0-F		
		3							XS2F-D422-GC0-F	—		
		4							XS2F-D422-G80-F	—		
		2			10				XS2F-D422-JA0-F	XS2F-A422-JB0-F		
		3							XS2F-D422-JC0-F	—		
		4							XS2F-D422-J80-F	—		
Non-polar DC Connectors with Standard PVC cable		Straight	2	6.6 dia.				2	XS2F-D421-310	XS2F-A421-310	—	
	2		5			XS2F-D421-410	XS2F-A421-410					
	Right-angle	2	2			XS2F-D422-310	—					
		2	5			XS2F-D422-410	XS2F-A422-410					
E2E models with conventional connector pin with Fire-retardant, PVC robot cable	Straight	2			2	XS2F-D421-DD0	—	—				
		2			5	XS2F-D421-GD0	—					
	Right-angle	2			2	XS2F-D422-DD0	—					
		2			5	XS2F-D422-GD0	—					
Heat-resistant cable up to 105°C *	Straight	4			2	XS2F-E421-D80-E	—	—				
					5	XS2F-E421-G80-E	—					
	Right-angle				2	2	XS2F-E422-D80-E		—			
					5	5	XS2F-E422-G80-E		—			
Spatter-resistant cable	Straight	4	6.6 dia.		2	XS2F-D421-D80-SA	—	—				
					5	5	XS2F-D421-G80-SA		—			
Standard PVC cable	Straight	5	6.0 dia.	0.3	2	XS2F-D521-DG0-A	—	—				
					5	5	XS2F-D521-GG0-A		—			
	Right-angle				10	10	XS2F-D521-JG0-A		—			
					2	2	XS2F-D522-DG0-A		—			
					5	5	XS2F-D522-GG0-A	—				

Note: Ask your OMRON representative about other cable lengths.

*The heat-resistant fixture material is SUS316L stainless steel without surface treatment.

Dimensions

Straight Connectors

Fire-retardant, PVC robot cable

XS2F-D421-□□□0-F

XS2F-A421-□□□0-F

Non-polar DC Connectors with Standard PVC cable

XS2F-D421-□□□0

XS2F-A421-□□□0

E2E models with conventional connector pin with Fire-retardant, PVC robot cable

XS2F-D421-□□□0

Heat-resistant cable up to 105°C

XS2F-E421-□□80-E

Spatter-resistant cable

XS2F-D421-□□80-SA

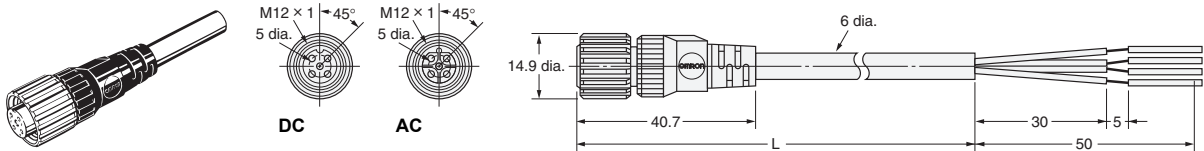

Right-angle Connectors

Fire-retardant, PVC robot cable

XS2F-D422-□□□0-F

XS2F-A422-□□□0-F

Non-polar DC Connectors with Standard PVC cable

XS2F-D422-□□□0

XS2F-A422-□□□0

E2E models with conventional connector pin with Fire-retardant, PVC robot cable

XS2F-D422-□□□0

Heat-resistant cable up to 105°C

XS2F-E422-□□80-E

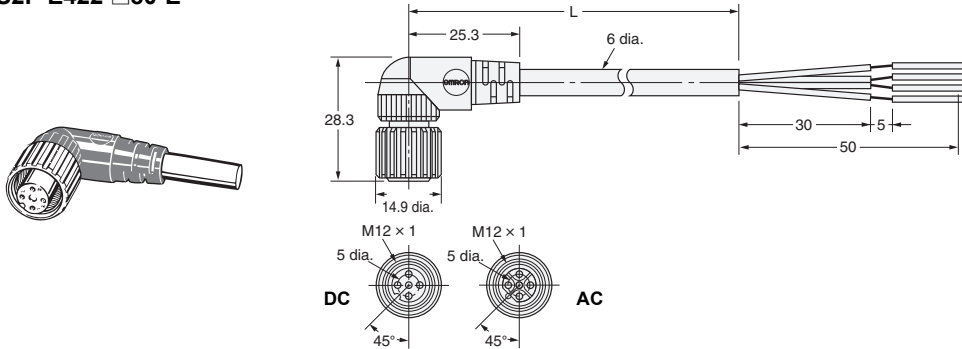

Wiring Diagram

		Two-core	Three-core	Four-core
Fire-retardant, PVC robot cable	XS2F-□42□-□□□0-F			
Spatter-resistant cable *	XS2F-D421-□□80-SA			
Heat-resistant cable up to 105°C *	XS2F-E42□-□□80-E			
Non-polar DC Connectors with Standard PVC cable	XS2F-□42□-□□□0		—	—
E2E models with conventional connector pin with Fire-retardant, PVC robot cable	XS2F-D42□-□□D0		—	—

*Spatter-resistant Cables and Heat-resistant Cables (105°C) are available only for four cores and DC.

Dimensions

Straight
Standard PVC cable
XS2F-D521-□G0-A

Note:
 Use the XS2H-D521-□G0-A in combination
 with the XS2F-D521-□G0-A.

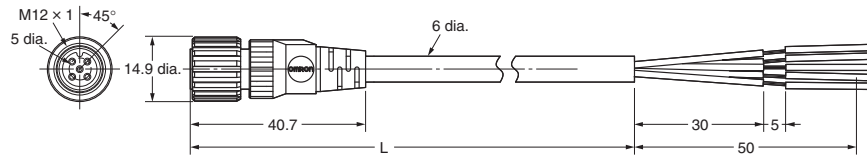
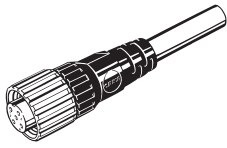

Wiring Diagram

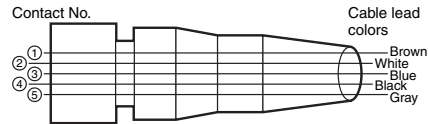

Right-angle
Standard PVC cable
XS2F-D522-□G0-A

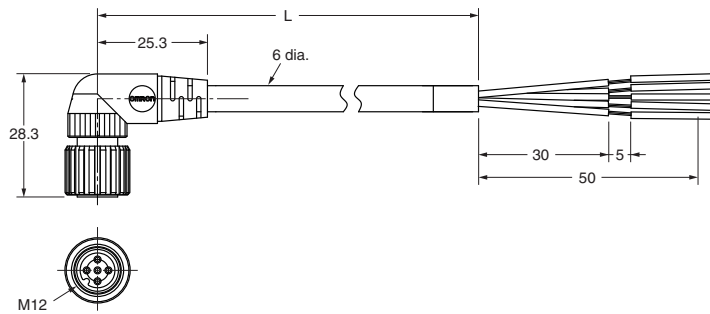
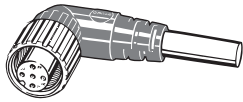

For details on connecting with E2E Proximity Sensors, refer to E2E Small-diameter Proximity Sensor Data Sheet (Cat. No.: SCEC-044).

XS2F-G/H Connectors with Cables, Socket on One Cable End, Screw Loosening-preventing Structure Type

Model Number Structure

Model Number Legend

Use this model number legend to identify products from their model number. Use this model number legend to identify products from their model number. When ordering, use a model number from the table in *Ordering Information*.

XS2F-□42□-□□□-F

1
2
3
4
5

1. Type

F: Connector with cables, sockets on one cable end

2. AC/DC

G: For DC
H: For AC

3. Cable Connection Direction

1: Straight
2: Right-angle

4. Cable Length

G80 : 5m (for DC)
G90 : 5m (for AC)
J80 : 10m (for DC)
J90 : 10m (for AC)

5. Structure

Screw Loosening-preventing

Ordering Information

Cable connection direction	No. of cable cores	Cable length L (m)	DC	AC	UL
			Model	Model	
Straight	4	5	XS2F-G421-G80-F	XS2F-H421-G90-F	UL 2238 certified (File No. E207683)
		10	XS2F-G421-J80-F	XS2F-H421-J90-F	
Right-angle		5	XS2F-G422-G80-F	XS2F-H422-G90-F	
		10	XS2F-G422-J80-F	XS2F-H422-J90-F	

Dimensions

Straight

XS2F-G421-□80-F

XS2F-G421-□90-F

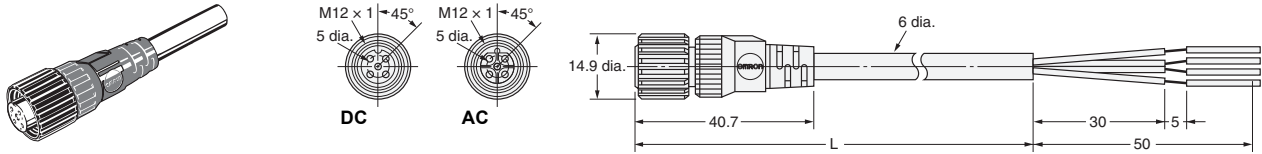

Right-angle

XS2F-G422-□80-F

XS2F-G422-□90-F

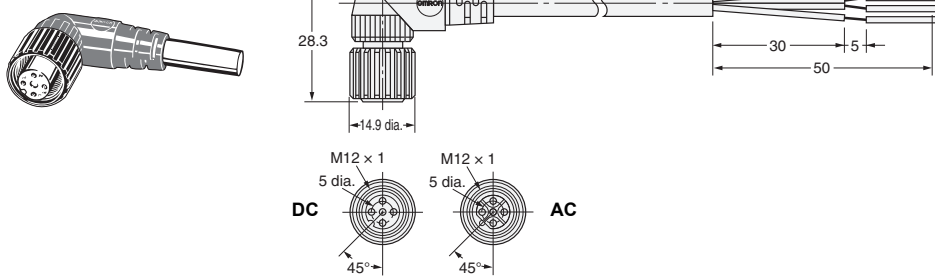

Features

Screw Loosening-preventing Structure

Appearance

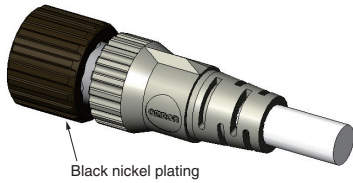

Black nickel plating

Structure

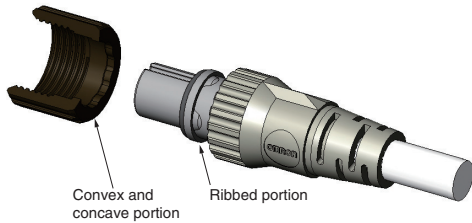

Convex and concave portion
Ribbed portion

By the above structure, the convex and concave portion of the thread bracket and housing ribs interfere with each other at 45° increments to work as a loosening-preventing mechanism when engaged.

XS2F Sockets on One Cable End with Indicator

Model Number Structure

Model Number Legend

Use this model number legend to identify products from their model number. Use this model number legend to identify products from their model number. When ordering, use a model number from the table in *Ordering Information*.

XS2F-M12PVC□A□□M□LED

1 2 3 4 5 6 7 8

1. Type

F: Connector with cables, sockets on one cable end

4. Connector Poles

3: 3 poles
4: 4 poles

7. Applicable Sensors

P: PNP
N: NPN

2. Mating Section Form

M12: M12

5. Cable Connection Direction

A: Right-angle

8. With indicator

LED: With indicator

3. Cable Material

PVC: PVC

6. Cable Length

2 : 2 m
5 : 5 m
10 : 10 m

Ordering Information

Cable specifications	Cable connection direction	Cable diameter (mm)	No. of cable cores	Cable core cross-sectional area (mm ²)	Cable length L (m)	LED	Model	UL	
PVC	Right-angle	5 dia.	3	0.34	2	PNP	XS2F-M12PVC3A2MPLED	UL 2238 certified (File No. E207683)	
					5		XS2F-M12PVC3A5MPLED		
					10		XS2F-M12PVC3A10MPLED		
					2	NPN	XS2F-M12PVC3A2MNLED		
					5		XS2F-M12PVC3A5MNLED		
					10		XS2F-M12PVC3A10MNLED		
		5.4 dia.	4			2	PNP		XS2F-M12PVC4A2MPLED
						5			XS2F-M12PVC4A5MPLED
						10			XS2F-M12PVC4A10MPLED

Dimensions

(Unit: mm)

Right-angle

XS2F-M12PVC3A□MPLED
XS2F-M12PVC4A□MPLED

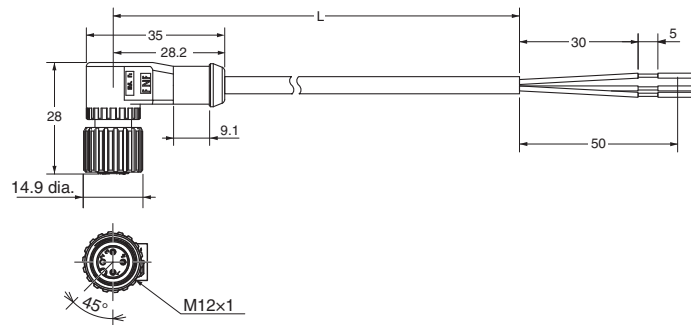
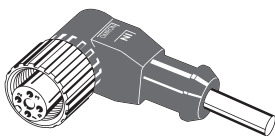

Wiring Diagram

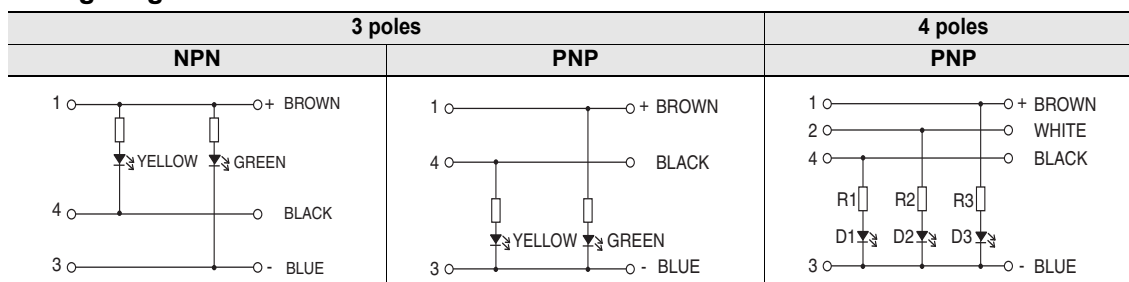

XS2H Plugs on One Cable End

Model Number Structure

Model Number Legend

Use this model number legend to identify products from their model number. When ordering, use a model number from the table in *Ordering Information*.

XS2H-□□21-□□0-□□

1
2
3
4
5
6
7
8
9

1. Type

H: Connector with cables, plug on one cable end

2. AC/DC

A: For AC
D: For DC

3. Connector Poles

4: 4 poles
5: 5 poles

4. Contact Plating

2: Gold plating

5. Cable Connection Direction

1: Straight

6. Cable Length

A : 0.3 m
B : 0.5 m
C : 1 m
D : 2 m
G : 5 m

7. Connections (Numbers inside circles are terminal numbers)

8 : ① Brown, ② White, ③ Blue, ④ Black (for DC)
 9 : ① Brown, ② White, ③ Blue, ④ Black (for AC)
 A : ① Brown, ② ---, ③ ---, ④ Blue (for DC)
 B : ① ---, ② ---, ③ Brown, ④ Blue (for AC)
 C : ① Brown, ② ---, ③ Blue, ④ Black (for DC)
 G : ① Brown, ② White, ③ Blue, ④ Black, ⑤ Gray

8. Connectors on One End/Both Ends

0: One end

9. Cable Specifications

A : Standard cable
 F : Fire-retardant, PVC robot cable
 SA : Spatter-resistant cable

XS2H Plugs on One Cable End

Ordering Information

Cable specifications	No. of connector poles	Cable connection direction	Cable diameter (mm)	No. of cable cores	Cable core cross-sectional area (mm ²)	Cable length L (m)	DC	AC	UL						
							Model	Model							
Fire-retardant, PVC robot cable	4	Straight Connectors	6.0 dia.	2	0.5	0.3	XS2H-D421-AA0-F	XS2H-A421-AB0-F	UL 2238 certified (File No. E207683)						
				3			XS2H-D421-AC0-F	—							
				4			XS2H-D421-A80-F	XS2H-A421-A90-F							
				2		1	0.5	XS2H-D421-B80-F		—					
				3			XS2H-D421-CA0-F	XS2H-A421-CB0-F							
				4			XS2H-D421-CC0-F	—							
				4			XS2H-D421-C80-F	XS2H-A421-C90-F							
				Spatter-resistant cable		4		6.6 dia.		4	0.3	0.3	XS2H-D421-A80-SA	—	—
												1	XS2H-D421-C80-SA	—	
				Standard cable		5		6.0 dia.		5	0.3	0.3	XS2H-D521-AG0-A	—	—
1	XS2H-D521-CG0-A	—													

Note: Ask your OMRON representative about other cable lengths.

Dimensions

(Unit: mm)

Straight (4 poles)

Fire-retardant, PVC robot cable XS2H-□421-□□0-F

Spatter-resistant cable XS2H-D421-□80-SA

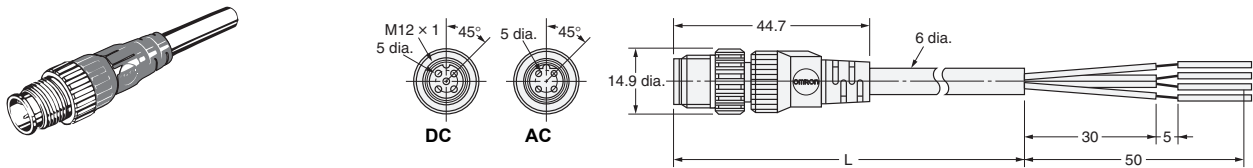

Wiring Diagram

Two-cores

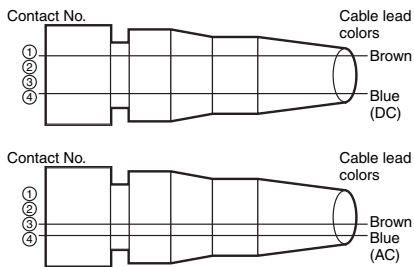

Three-cores

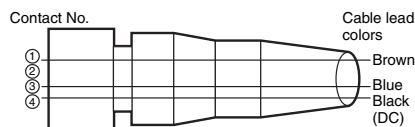

Four-cores

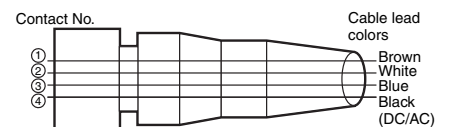

Straight (5 poles)

Standard cable XS2H-D521-□G0-A (For DC)

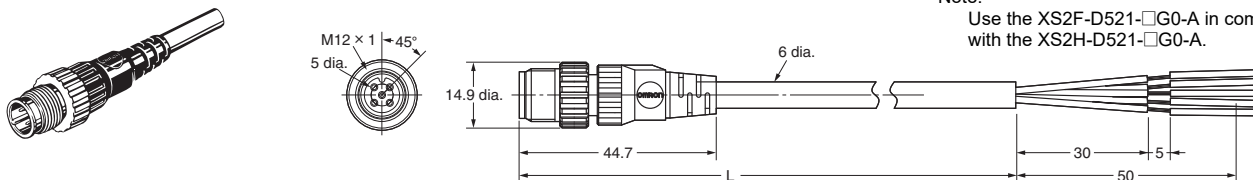

Note: Use the XS2F-D521-□G0-A in combination with the XS2H-D521-□G0-A.

Wiring Diagram

Five-cores



XS2 Sensor I/O Connectors on Cables (8-pole)

Ordering Information

Connector type	Cable connection direction	Number of cores	Cable length L (m)	Applicable wire diameter	Model	UL
Panel-mounting Plug	—	—	—	AWG22 to 28	XS2M-D824-4	—
Panel-mounting socket					XS2P-D821-2	
Plug on one cable end	Straight	8	0.3	—	XS2H-D821-AH0-C	UL 2238 certified (File No. E207683)
			1		XS2H-D821-CH0-C	
Socket on one cable end			2		XS2F-D821-DH0-C	
			5		XS2F-D821-GH0-C	
Plug and socket on both cable ends			2		XS2W-D821-DH1-C	
			5		XS2W-D821-GH1-C	

Note: Ask your OMRON representative about other cable lengths.
Ask your OMRON representative about PVC robot cable models (-R).

Ratings and Specifications

Rated current	1.5 A
Rated voltage	36 VDC
Contact resistance	40 mΩ max. (at 20 mVDC max. and 100 mA max.)
Insulation resistance	1,000 MΩ min. (at 500 VDC)
Dielectric strength	1,000 VAC for 1 min (leakage current: 1 mA max.)
Degree of protection	IP67
Insertion tolerance	200 times min.
Ambient operating temperature range	-25 to 70°C

Materials and Finish

Contacts	Brass, gold plating
Thread Bracket, body, M16 nuts	Brass/nickel plated
Pin block	PBT resin, light gray
Cover *1	Soft PBT resin
Seal rubber and O-ring *2	Rubber
Cable	Standard cable (8 core, shielded) 6 mm dia. AWG24

*1. XS2F/XS2H/XS2W only.
*2. O-rings are on sockets only.

Pins and Cable Lead Colors

XS2F/XS2H/XS2W cable lead colors	Pin No.							
	1	2	3	4	5	6	7	8
	White	Brown	Green	Yellow	Gray	Pink	Blue	Shield

Wiring

Wiring Example

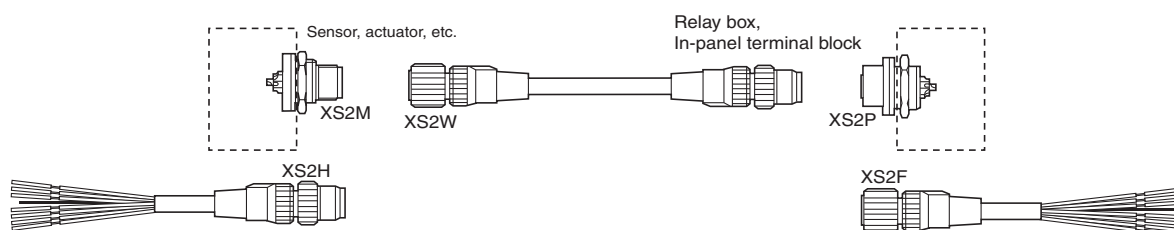

Dimensions

Plug on One Cable End (M12)
XS2H

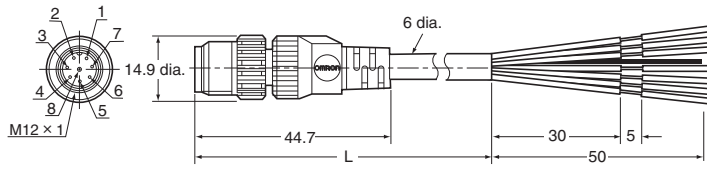
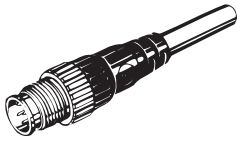

Socket on One Cable End (M12)
XS2F

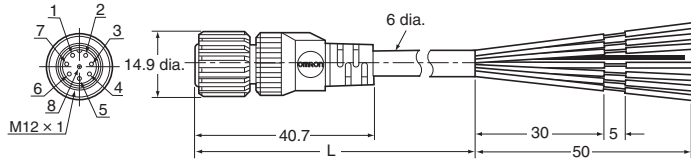
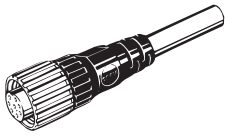

Socket and Plug on Both Cable Ends (M12)
XS2W

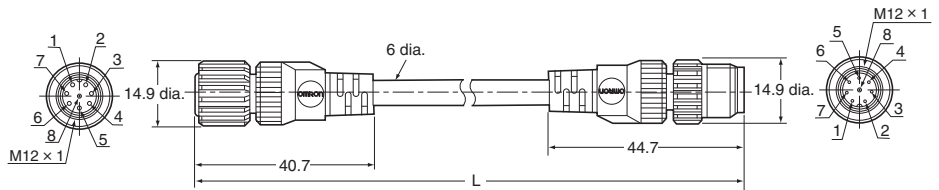
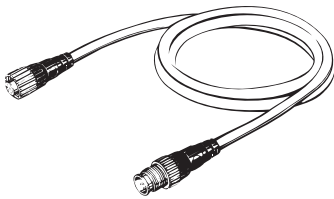

Panel-mounting Socket (M12)
Rear Lock Model
XS2P-D821-2 (with Solder Cup Pins)

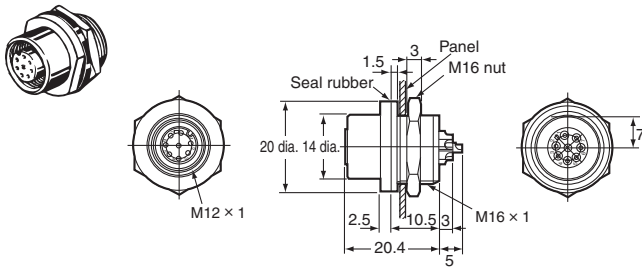

Panel-mounting Plug (M12)
Front Lock Model
XS2M-D824-4 (with Solder Cup Pins)

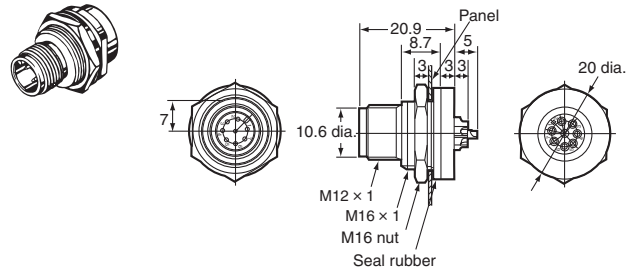

Panel-mounting Socket (M12)
Front Lock Model
XS2P-D822-2 (with Solder Cup Pins)

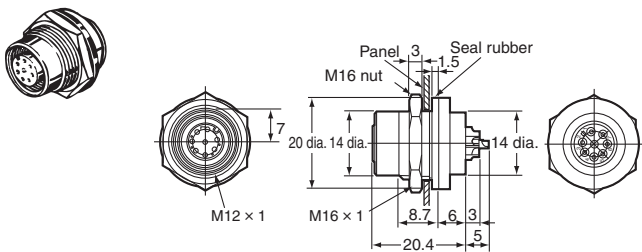

Panel Cutout

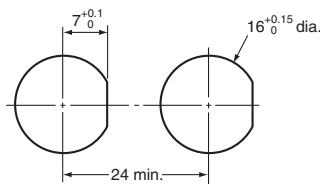

Connector Terminal Numbers (from Connection Side)

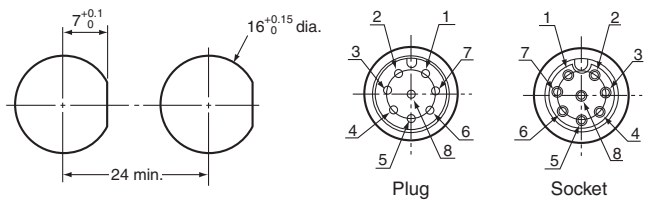

Note: 1. Mounting panel thickness: 1 to 4 mm.
2. Applicable core wire size for solder cup pins: 0.5 mm² max.
3. The M16 nut and seal rubber are included.

XS2G Crimping/Soldering Plug Assemblies

Ordering Information

Suitable cable (mm)	Core conductor size (mm ²)	Suitable sheath material	Cable connection direction	Connection method	DC	AC	UL
					Model	Model	
6 dia. (5 to 6 dia.)	0.18 to 0.3 0.5 to 0.75*	PVC, PE, PUR	Straight	Crimping	XS2G-D4C1	XS2G-A4C1	UL 2238 certified (File No. E207683)
	Soldering			XS2G-D421 XS2G-D422	XS2G-A421 —		
4 dia. (4 to 5 dia.)	0.18 to 0.3 0.5 to 0.75*		Straight	Crimping	XS2G-D4C3	XS2G-A4C3	
	0.5 max.			Soldering	XS2G-D423 XS2G-D424	XS2G-A423 —	
3 dia. (3 to 4 dia.)	0.18 to 0.3 0.5 to 0.75*		Straight	Crimping	XS2G-D4C5	XS2G-A4C5	
	0.5 max.			Soldering	XS2G-D425 XS2G-D426	XS2G-A425 —	

*There are two types of contacts.

Note: Crimping plug pins are sold separately.

Use a cable of mentioning. If you do not use one of these cables, there is a possibility that the performance can't be met.

Dimensions

(Unit: mm)

Straight Connectors

XS2G-□4C□ (Crimping Model)

XS2G-□42□ (Soldering Model)

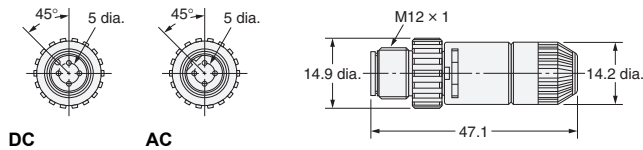
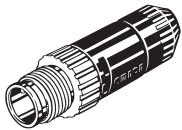

Right-angle

XS2G-D42□ (Soldering Model)

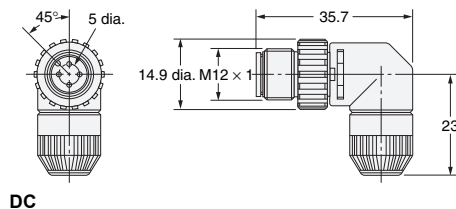
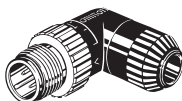

XS2U Crimping Pin for XS2G

Ordering Information

Suitable core size (mm ²)	Model
0.18 to 0.3	XS2U-3121
0.5 to 0.75	XS2U-3122

Dimensions

(Unit: mm)

XS2U-312□

* A special tool must be used for crimping. For details, refer to page 33.

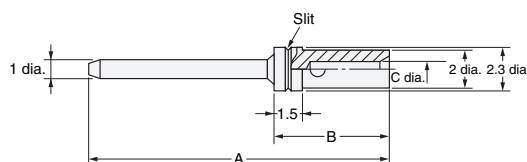
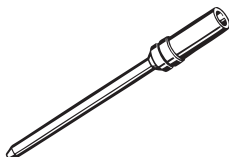

Dimensions

Model	Suitable core size (mm ²)	Dimension (mm)			No. of slits
		A	B	C	
XS2U-3121	0.18 to 0.3	20.0	6.1	0.8	1
XS2U-3122	0.5 to 0.75	20.1	6.2	1.3	0

XS2C Crimping/Soldering Socket Assemblies

Ordering Information

Suitable cable (mm)	Core conductor size (mm ²)	Suitable sheath material	Cable connection direction	Connection method	DC	AC	UL
					Model	Model	
6 dia. (5 to 6 dia.)	0.18 to 0.3 0.5 to 0.75* 0.5 max.	PVC, PE, PUR	Straight	Crimping	XS2C-D4C1	XS2C-A4C1	UL 2238 certified (File No. E207683)
				Soldering	XS2C-D421	XS2C-A421	
	Right-angle		Crimping	XS2C-D4C2	XS2C-A4C2		
			Soldering	XS2C-D422	XS2C-A422		
4 dia. (4 to 5 dia.)	0.18 to 0.3 0.5 to 0.75* 0.5 max.		Straight	Crimping	XS2C-D4C3	XS2C-A4C3	
				Soldering	XS2C-D423	XS2C-A423	
	Right-angle		Crimping	XS2C-D4C4	XS2C-A4C4		
			Soldering	XS2C-D424	XS2C-A424		
3 dia. (3 to 4 dia.)	0.18 to 0.3 0.5 to 0.75* 0.5 max.	Straight	Crimping	XS2C-D4C5	XS2C-A4C5		
			Soldering	XS2C-D425	XS2C-A425		
	Right-angle	Crimping	XS2C-D4C6	XS2C-A4C6			
		Soldering	XS2C-D426	XS2C-A426			

*There are two types of contacts.

Note: Crimping plug contacts are sold separately.

Use a cable of mentioning. If you do not use one of these cables, there is a possibility that the performance can't be met.

Dimensions

(Unit: mm)

Straight Connectors

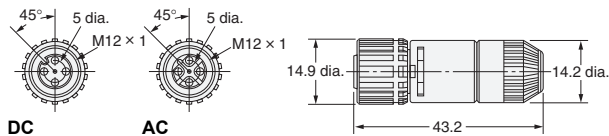
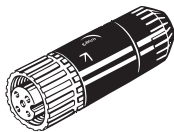

Right-angle Connectors

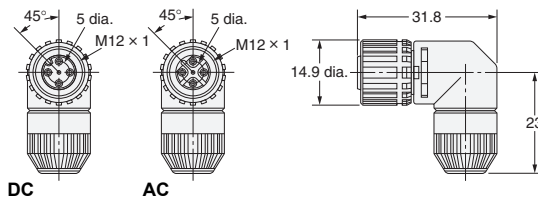

XS2U Crimping Pin for XS2C

Ordering Information

Suitable core size (mm ²)	Model
0.18 to 0.3	XS2U-2221
0.5 to 0.75	XS2U-2222

Dimensions

(Unit: mm)

Socket Pin

* A special tool must be used for crimping. For details, refer to page 33.

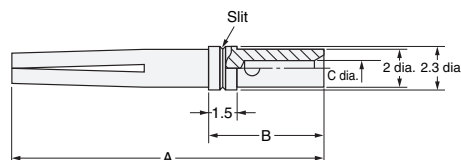

Dimensions

Model	Suitable core size (mm ²)	Dimension (mm)			No. of slits
		A	B	C	
XS2U-2221	0.18 to 0.3	16.7	6.1	0.8	1
XS2U-2222	0.5 to 0.75	16.8	6.2	1.3	0

XS2G Screw-on Plug Assemblies

Ordering Information

No. of poles	Suitable cable (mm)	Core conductor size (mm ²)	Suitable sheath material	Straight connectors (for DC)	Right-angle connectors (for DC)	UL
				Model	Model	
5	8 dia. (7 to 8 dia.)	0.18 to 0.75	PVC, PE, PUR	XS2G-D5S7	—	UL 2238 certified (File No. E207683)
	7 dia. (6 to 7 dia.)			XS2G-D5S9	—	
	6 dia. (5 to 6 dia.)			XS2G-D5S1	XS2G-D5S2	
4	8 dia. (7 to 8 dia.)			XS2G-D4S7	—	
	7 dia. (6 to 7 dia.)			XS2G-D4S9	—	
	6 dia. (5 to 6 dia.)			XS2G-D4S1	XS2G-D4S2	
	4 dia. (4 to 5 dia.)			XS2G-D4S3	XS2G-D4S4	
	3 dia. (3 to 4 dia.)			XS2G-D4S5	XS2G-D4S6	

Note: XS2G Screw-on Plugs cannot be connected to side by side to the CN1 and CN2 connectors of XS2R Y-Joint Sockets/Plugs.
Use a cable of mentioning. If you do not use one of these cables, there is a possibility that the performance can't be met.

Dimensions

(Unit: mm)

Straight Connectors

Applicable Cable Outer Diameter: 8 mm

XS2G-D5S7 (5poles)

XS2G-D4S7 (4 poles)

Applicable Cable Outer Diameter: 7 mm

XS2G-D5S9 (5poles)

XS2G-D4S9 (4 poles)

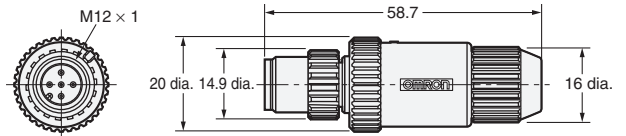
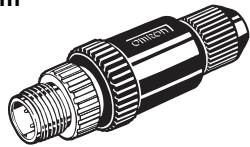

Straight Connectors

Applicable Cable Outer Diameter: 6 mm

XS2G-D5S1 (5poles)

XS2G-D4S1 (4 poles)

Applicable Cable Outer Diameter: 4 mm

XS2G-D4S3 (4 poles)

Applicable Cable Outer Diameter: 3 mm

XS2G-D4S5 (4 poles)

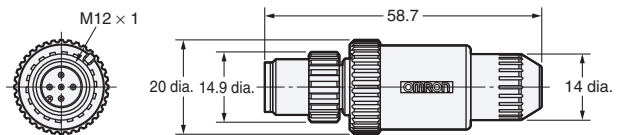
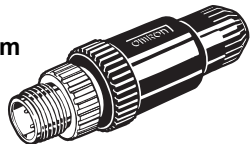

Right-angle Connectors

Applicable Cable Outer Diameter: 6 mm

XS2G-D5S2 (5poles)

XS2G-D4S2 (4 poles)

Applicable Cable Outer Diameter: 4 mm

XS2G-D4S4 (4 poles)

Applicable Cable Outer Diameter: 3 mm

XS2G-D4S6 (4 poles)

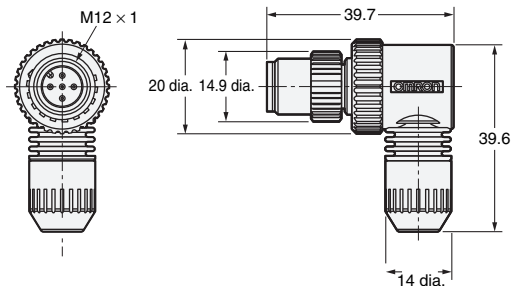
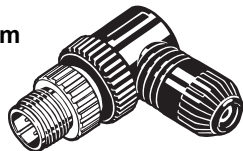

XS2C Screw-on Socket Assemblies

Ordering Information

No. of poles	Suitable cable (mm)	Core conductor size (mm ²)	Suitable sheath material	Straight connectors (for DC)	Right-angle connectors (for DC)	UL
				Model	Model	
5	8 dia. (7 to 8 dia.)	0.18 to 0.75	PVC, PE, PUR	XS2C-D5S7	—	UL 2238 certified (File No. E207683)
	7 dia. (6 to 7 dia.)			XS2C-D5S9	—	
	6 dia. (5 to 6 dia.)			XS2C-D5S1	XS2C-D5S2	
4	8 dia. (7 to 8 dia.)			XS2C-D4S7	—	
	7 dia. (6 to 7 dia.)			XS2C-D4S9	—	
	6 dia. (5 to 6 dia.)			XS2C-D4S1	XS2C-D4S2	
	4 dia. (4 to 5 dia.)			XS2C-D4S3	XS2C-D4S4	
	3 dia. (3 to 4 dia.)			XS2C-D4S5	XS2C-D4S6	

Note: Use a cable of mentioning. If you do not use one of these cables, there is a possibility that the performance can't be met.

Dimensions

(Unit: mm)

Straight Connectors

Applicable Cable Outer Diameter: 8 mm

XS2C-D5S7 (5 poles)

XS2C-D4S7 (4 poles)

Applicable Cable Outer Diameter: 7 mm

XS2C-D5S9 (5 poles)

XS2C-D4S9 (4 poles)

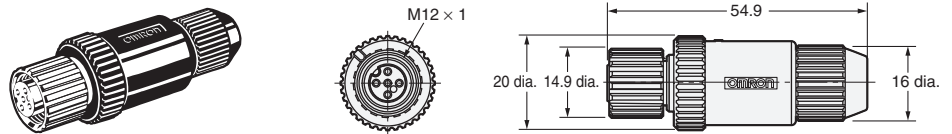

Straight Connectors

Applicable Cable Outer Diameter: 6 mm

XS2C-D5S1 (5 poles)

XS2C-D4S1 (4 poles)

Applicable Cable Outer Diameter: 4 mm

XS2C-D4S3 (4 poles)

Applicable Cable Outer Diameter: 3 mm

XS2C-D4S5 (4 poles)

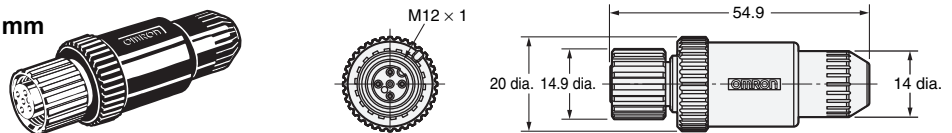

Right-angle Connectors

Applicable Cable Outer Diameter: 6 mm

XS2C-D5S2 (5 poles)

XS2C-D4S2 (4 poles)

Applicable Cable Outer Diameter: 4 mm

XS2C-D4S4 (4 poles)

Applicable Cable Outer Diameter: 3 mm

XS2C-D4S6 (4 poles)

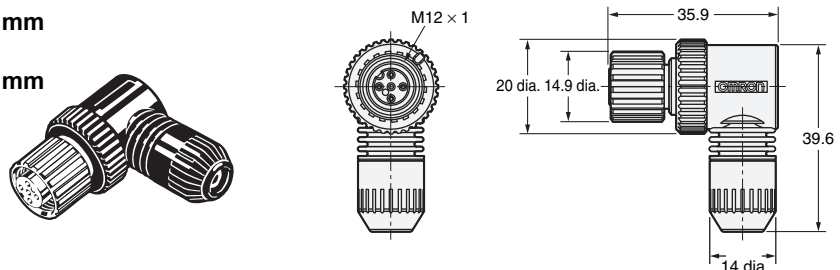

XS2C/XS2G Safety Precautions

Assembly Procedure for XS2C/XS2G Connector Assemblies

(1) Connector and Cable Diameters

- Connectors for 8, 7, 6, 4, and 3 mm diameter Cables (i.e., Cables that are 7 to 8, 6 to 7, 5 to 6, 4 to 5, and 3 to 4 mm in diameter respectively) are available.
- When assembling a Connector used with a cable, make sure that the external diameter of the Connector is suited to that of the cable.
- A waterproof bushing for 6/7 mm diameter Cable has no stripe, that for 8/4 mm diameter Cable has a single stripe, and that for 3 mm diameter Cable has two stripes.

(2) Component Insertion

Crimping/Soldering Connectors

Straight Connectors

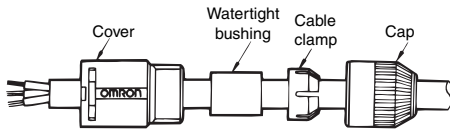

Right-angle Connectors

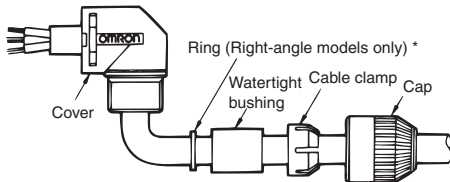

*A ring is not required for Screw-on Connectors.

- As shown in the above illustration, connect the above components to the Cable with its end processed.

Screw-on Connectors

Confirm that you have all of the required parts.

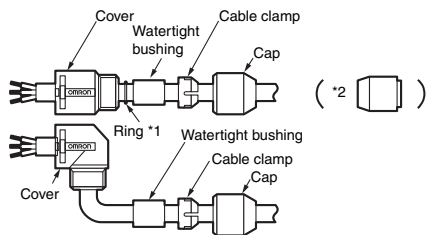

Insulation caps and insulation tubes are included with 5-pole Connectors (XS2C-D5S□ and XS2G-D5S□).

- *1. Rings are not required with 7-mm and 8-mm cables.
- *2. Insert the waterproof bushing for 7-mm and 8-mm cables in the direction shown in the diagram.

(3) Wiring (Dressing the Cable Ends)

Soldering Connectors

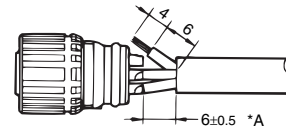

- Strip 10 mm of the Cable sheath and 4 mm of each core.
- Before soldering cores and solder cup pins together, solder-coat each of them.
- The following conditions are recommended for soldering each solder cup pin.
Soldering temperature: 350±5°C
Soldering period: 3±1 s
- The length marked *A should be 6.5 mm max., otherwise the proper degree of protection of the connector will not be maintained.

Crimping Connectors

Crimping

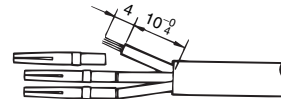

- Strip 14 mm of the Cable sheath and 4 mm of each core.
- Make sure that each core is not damaged and its end strands are not spread out.
- Mount the XY2F-0003 Locator to XY2F-0002 Crimp Tool, both of which are sold separately, and set the selector dial of the Crimp Tool to 8.
- After mounting the crimping pins to the Locator, fully insert the cores to the crimping pins.
- Squeeze the handle of the Crimp Tool to press-fit the cores to the crimping pins.
(Squeeze the handle firmly until the handle automatically returns to the release position.)

Wiring

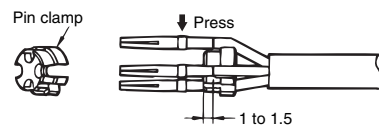

- After press-fitting the cores to the pins, insert the pins into the pin clamp as shown in the illustration. Then make sure that the lead colors correspond to the pin clamp numbers that are identical to the connector pin numbers.

Insertion

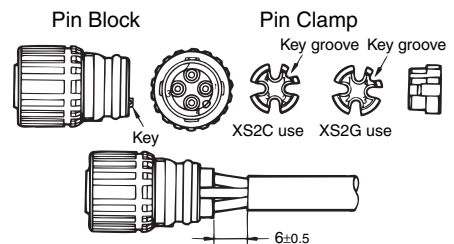

- Tentatively insert the pins to the pin block holes so that the key on the pin block will coincide with the key groove on the pin clamp. Then insert the cable along with the pin clamp.

Screw-on Connectors

Dressing the Cable End

• **Four-pole Connectors**

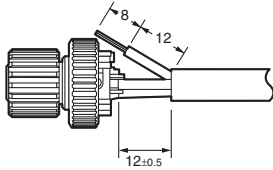

- Loosen the screws on pins 1 to 4 and insert the cores according to the pin numbers.

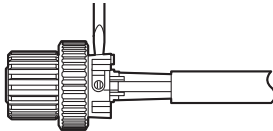

- Use the dedicated Screwdriver (XW4Z-00B)* and tighten the screws securely so that the cores do not pull out. (0.15 to 0.2 N·m)

• **Five-pole Connectors**

- Strip the cable sheath for a total of 15 mm and strip the core covering for 8 mm for the core to connect to pin 5.

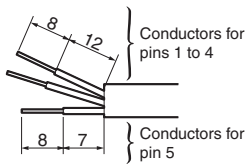

- Connect the core to pin 5 (in the center) first.
- Insert the core from the side of the hold with the tab and tighten the screw securely (tightening torque: Pins 1 to 4: 0.15 to 0.2 N·m, Pin 5: 0.03 to 0.05 N·m), and then cut off the excess wire with wire cutters.

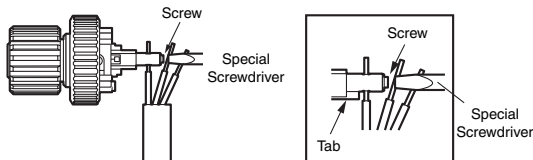

- Bend the cable as shown below, attached the enclosed insulation cap, and then strip the other cores.

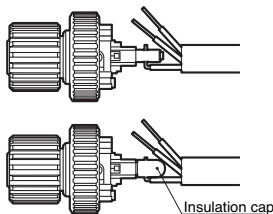

- Connect the cores to pins 1 to 4.

Connecting Shielded Cables to Five-pole Connectors

- Place the insulation tub on the drain line of the shield and connect it to the terminal.
- Tighten the screw and then check visually to see if there is insulation between the cores.

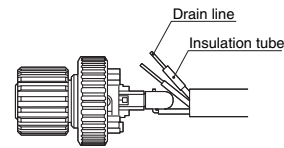

*When tightening the screws, use the dedicated XW4Z-00B Screwdriver that matches with the screw-slot dimensions.

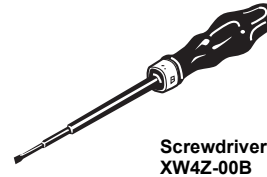

(4) Inserting Pin Block

Pin block (Soldering Model) Cover (Straight Model)

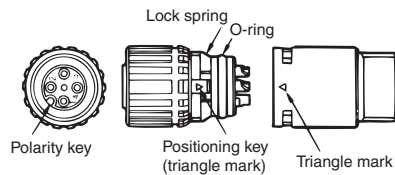

(Crimping Model) (Right-angle Model)



- Mount the cover to the pin block so that the triangle mark on the pin block will coincide with the triangle mark on the cover.
- If the cover is used for a Right-angle model, the relationship between the position of the polarity key on the engaged side and cable connection direction will be determined by the direction in which the positioning key is inserted into the cover, which can be rotated by 90°.
- Fully insert the positioning key until the positioning key is hidden by the casing.

Pin block (Screw-on Connectors)

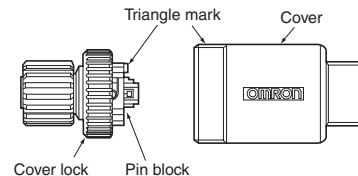

- Align the triangular marks on the pin block and cover and insert the pin block into the cover.
- Press them together firmly until the pin block does not come out of the cover. (0.39 to 0.49 N·m)

(5) Mounting Cap

- After mounting the cover to the pin block and the cover snaps into place, tighten the cap securely by hand (0.39 to 0.49 N·m)

Note: If the cap is not tighten securely enough, the degree of protection (IP67) may not be maintained or vibration may cause the cap to become loose. Do not tighten the cap with pliers or similar tools; they may damage the cap.

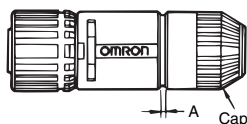

- After fully tightening the cap, length A should be approximately one of the following according to the cable external diameter and the Connector model. (Use these as a guide.)

External diameter of applicable cable	Cable external diameter (mm)			
	6 mm	5 mm	4 mm	3 mm
For 6-mm-dia. cable	1	0	—	—
For 4-mm-dia. cable	—	2	1	—
For 3-mm-dia. cable	—	—	2	1

(6) After Assembly

- Confirm the insulation between cores after completing assembly.

Recommended Cables

When connecting a commercially available cable to a connector assembly, use a cable with an outside diameter of 3 to 6 mm and core conductor sizes of 0.18 to 0.75 mm² for crimping connectors and 0.5 mm² maximum for soldering connectors.

Connector Arrangement

For safety, when constructing a connection system between a Sensor and panel with a connector, make sure that the connector plug is on the Sensor side and the connector socket is on the panel side (i.e., the female pins are located on the power-supply side).

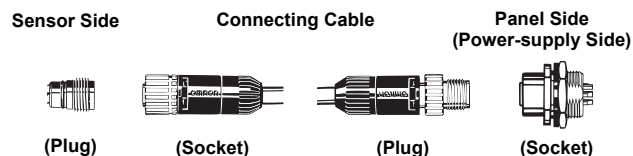

XS2P Panel-mounting Sockets for Terminal Boxes

Ordering Information

No. of poles	Lock method	Pin shape*	Applicable wire diameter	DC	AC	UL
				Model	Model	
4	Rear lock	Solder cup pin	AWG20 to 28	XS2P-D421-2	XS2P-A421-2	UL 2238 certified (File No. E207683)
	Front lock	Solder cup pin		XS2P-D422-2	XS2P-A422-2	
		DIP pin		XS2P-D422-1	—	
5	Front lock	Solder cup pin		XS2P-D522-2	—	—
		DIP pin		XS2P-D522-1	—	

*The solder cup pin is for wire mounting, and the DIP pin is for PCB mounting. Soldering is required for both pins.

Dimensions

(Unit: mm)

Rear Lock Model

XS2P-□421-2 (with Solder Cup Pins)

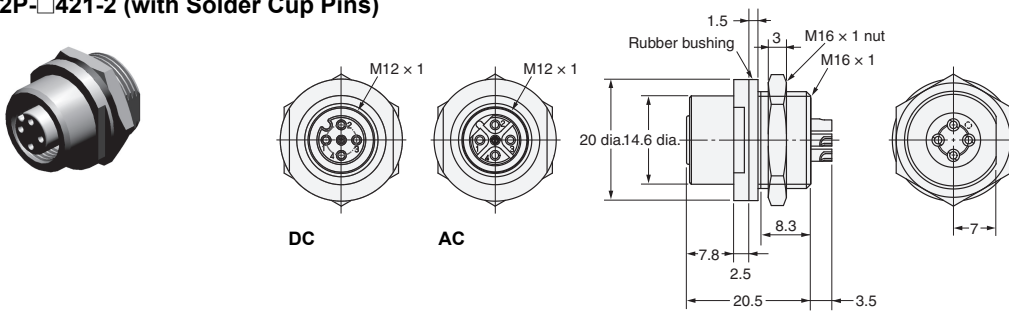

Front Lock Model

XS2P-□422-1 (with DIP Pins)

XS2P-□422-2 (with Solder Cup Pins)

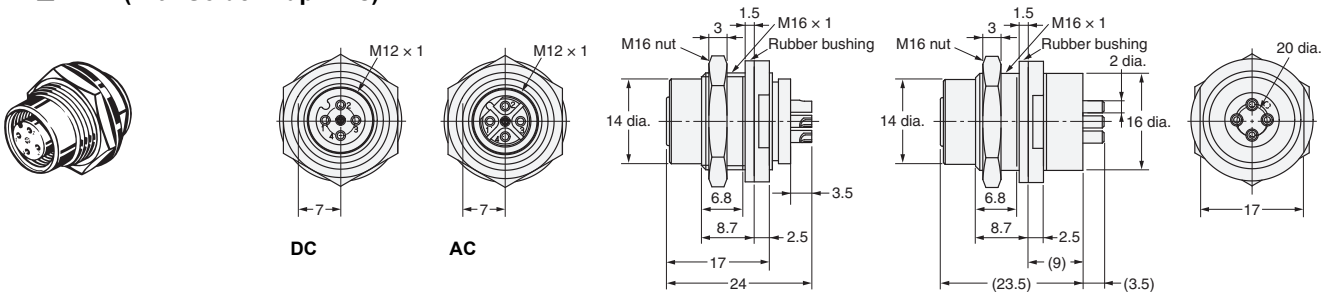

Front Lock Model

XS2P-D522-1 (with DIP Pins)

XS2P-D522-2 (with Solder Cup Pins)

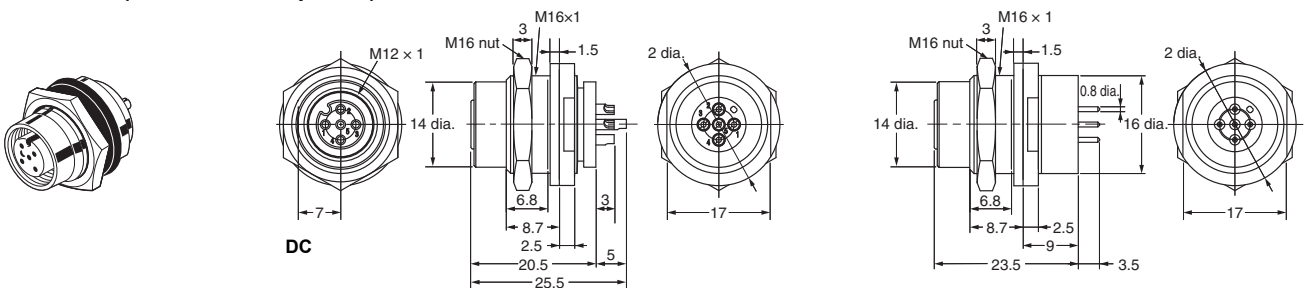

Panel Cutout

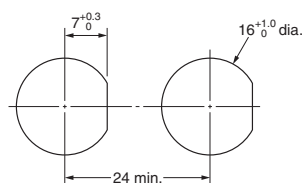

Note: The panel thickness is 1 to 4 mm.

PCB-mounting Dimensions With DIP Pins

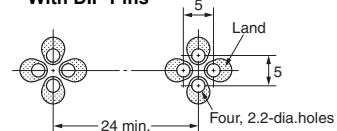

XS2R Y-Joint Plug/Socket Connectors

Ordering Information

Cable	Connector	DC		UL
		Cable length L (m)	Model	
With cable	Connectors on both cable ends	0.5	XS2R-D426-B11-F	UL 2238 certified (File No. E207683)
		1	XS2R-D426-C11-F	
		2	XS2R-D426-D11-F	
		3	XS2R-D426-E11-F	
	Connector on one cable end	2	XS2R-D426-D10-F	
		5	XS2R-D426-G10-F	
Cable	Connector	DC		UL
		Cable length L (m)	Model	
Without cable	Connectors on both cable ends	—	XS2R-D426-1	—
			XS2R-D426-5	
			XS2R-D426-81	
			XS2R-D426-82	

Note: XS2G Screw-on Plugs cannot be connected side-by-side to the CN1 and CN2 connectors.
Consider using a crimping or soldering model instead. Refer to page 18 for details.

Dimensions

(Unit: mm)

Connectors on Both Cable Ends (Y-Joint Plug/Socket) XS2R-D426-□11-F

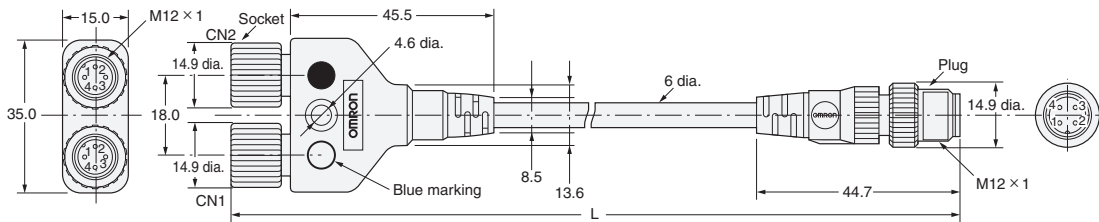

Wiring Diagram

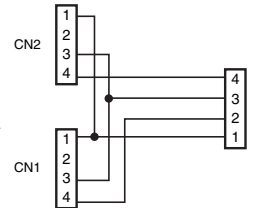

Connectors on One Cable End (Y-Joint Socket) XS2R-D426-□10-F

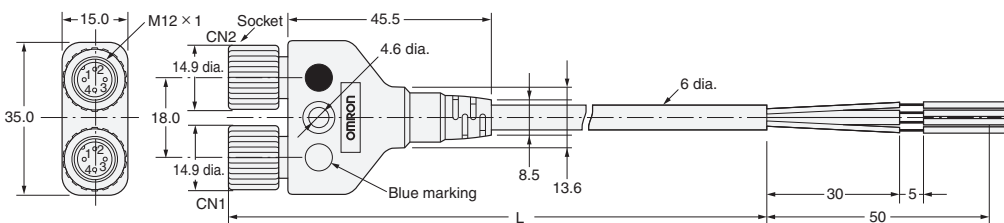

Wiring Diagram

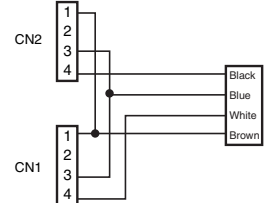

Y-Joint Plug/Socket without Cable XS2R-D426-1

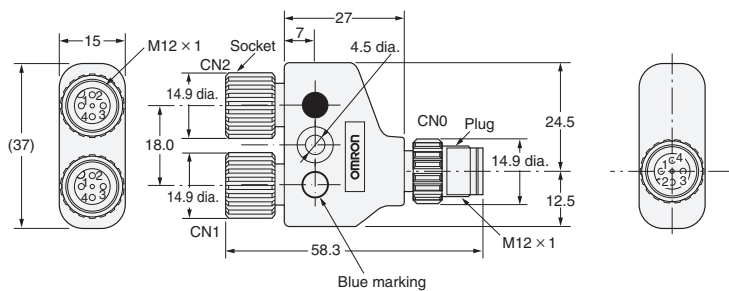

Wiring Diagram

XS2R-D426-1

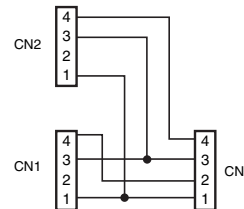

XS2R-D426-5

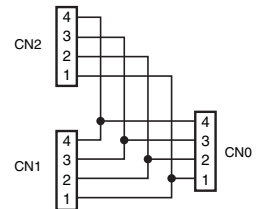

XS2R-D426-81

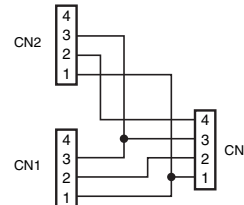

XS2R-D426-82

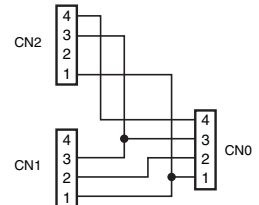

XS2R T-Joint Plug/Socket Connectors

Ordering Information

Type	DC	UL
	Model	
Aggregate model	XS2R-D422-1	UL 2238 certified (File No. E207683)
	XS2R-D422-5	
Bifurcated model	XS2R-D423-1	
Daisy-chain model	XS2R-D424-1	

Dimensions

(Unit: mm)

Aggregate model
XS2R-D422-1
XS2R-D422-5

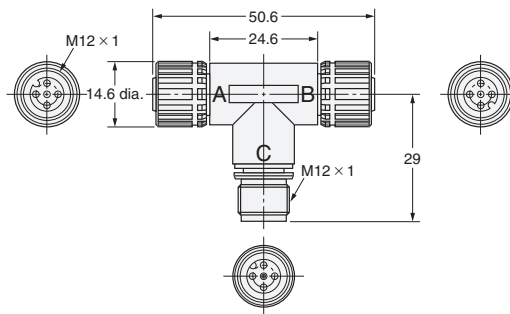
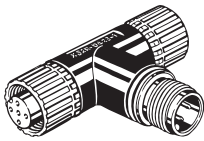

Wiring Diagram
XS2R-D422-1

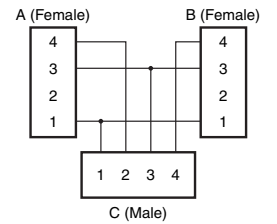

XS2R-D422-5

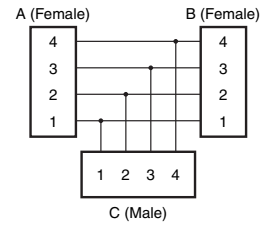

Bifurcated model
XS2R-D423-1

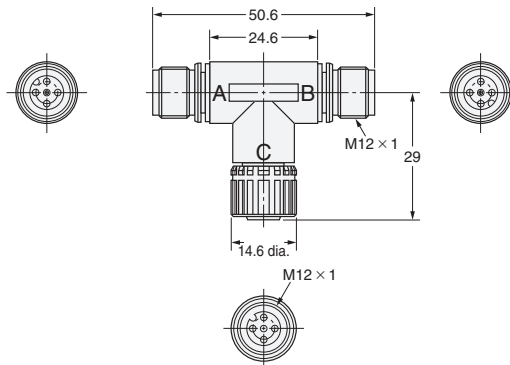
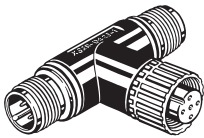

Wiring Diagram

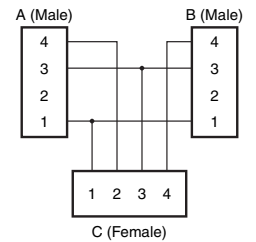

Daisy-chain model
XS2R-D424-1

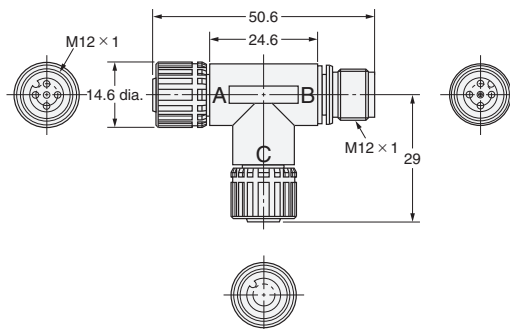
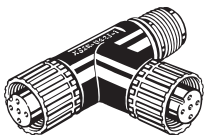

Wiring Diagram

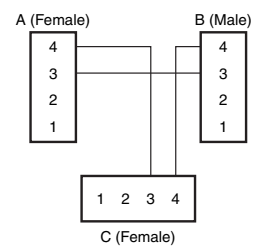

Features

XS2R Application Examples

XS2R-D422-1 (Aggregate Model)

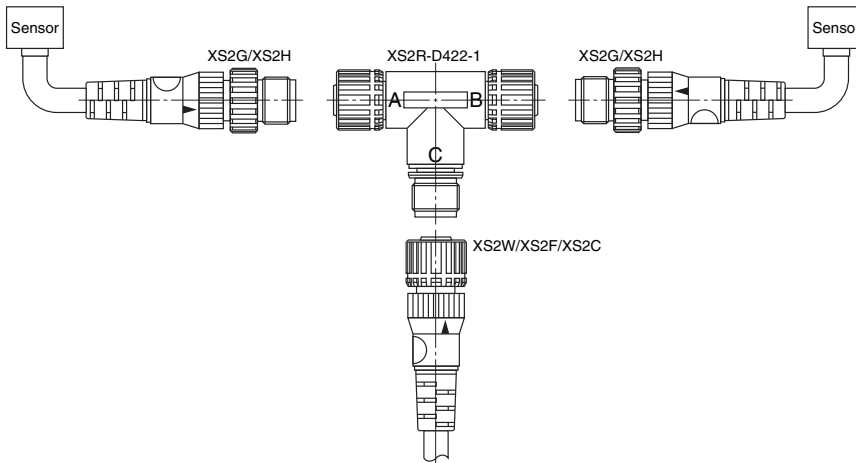

- A pair of Two-wire Sensors or Three-wire Sensors can be connected as shown in the illustration.
- The XS2R-D422-5 has feed through connections, thus working as a connector for the extension cable.

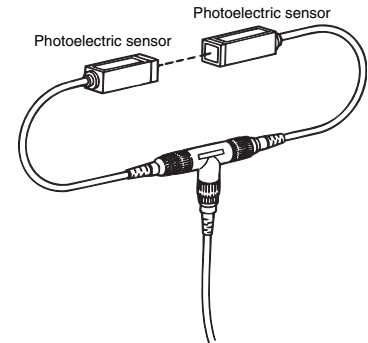

XS2R-D423-1 (Bifurcated Model)

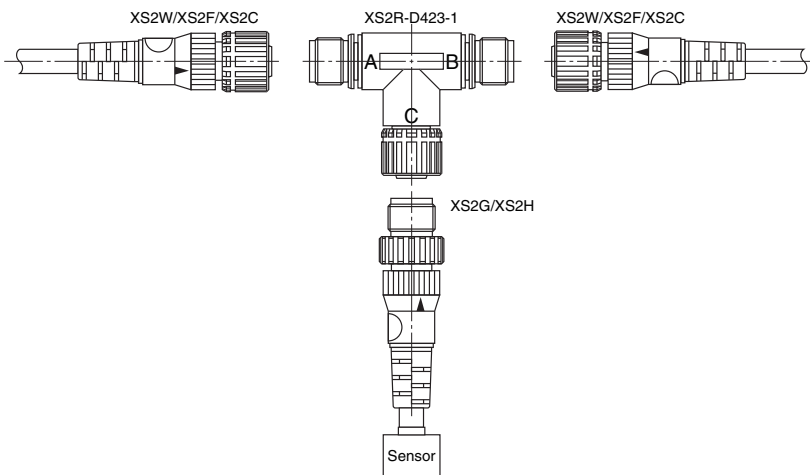

- Two or Three-wire Sensor signals can be bifurcated.

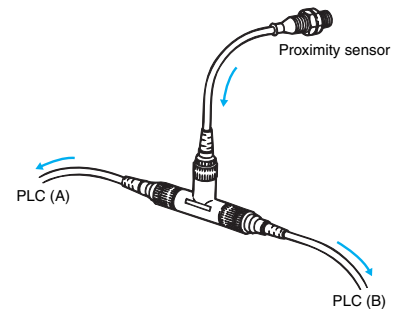

XS2R-D424-1 (Daisy Chain Model)

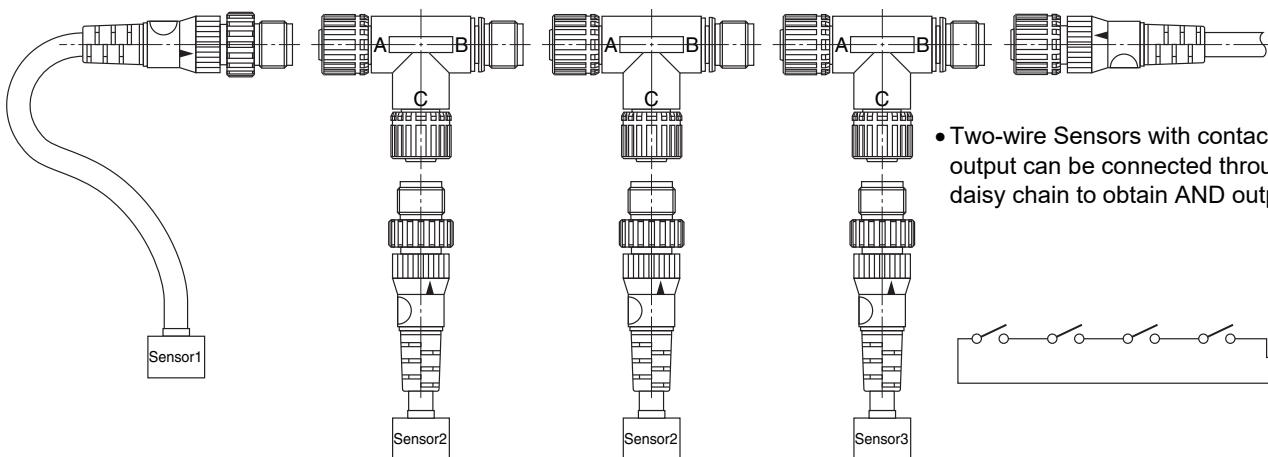

- Two-wire Sensors with contact output can be connected through a daisy chain to obtain AND output.

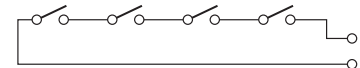

Safety Precautions

Precautions for Correct Use

Do not use the product in atmospheres or environments that exceed product ratings.

- Before using the XS2R for Sensors, make sure that the wiring of the Sensors and the internal connections of the XS2R are correct.

XS2M Sensor-embedded Plugs

Ordering Information

No. of poles	Mounting method	Pin shape	Applicable wire diameter	DC	AC	UL
				Model	Model	
4	Embedded with screw threads	Solder cup pin	AWG22 to 28	XS2M-D421	XS2M-A421	UL 2238 certified (File No. E207683)
	Embedded without screw threads			XS2M-D422	XS2M-A422	

Dimensions

(Unit: mm)

Embedded with screw threads

XS2M-D421 (For DC)
XS2M-A421 (For AC)

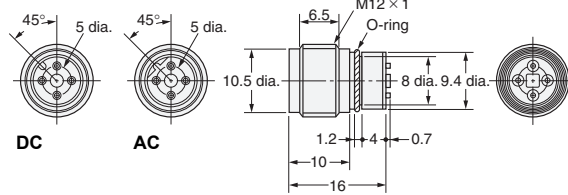

Mounting Dimensions

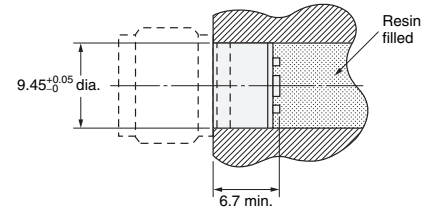

Note: After mounting, anchor the solder cup pins by injecting resin.

Embedded without screw threads

XS2M-D422 (For DC)
XS2M-A422 (For AC)

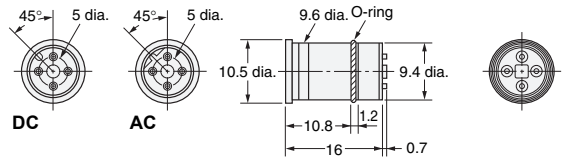

Mounting Dimensions

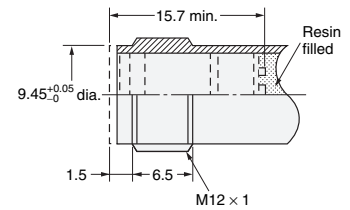

Note: After mounting, anchor the solder cup pins by injecting resin.

XS2M Panel-mounting Plugs

Ordering Information

Resin Body

No. of poles	Mounting method	Pin shape*1	Applicable wire diameter	DC	AC	UL
				Model	Model	
4	Flange-mounting	Solder cup pin	AWG22 to 28	XS2M-D423	XS2M-A423	UL 2238 certified (File No. E207683)
	Screw-mounting	DIP pin	—	XS2M-D424-1	XS2M-A424-1	
		Solder cup pin	AWG20 to 28	XS2M-D424-2	XS2M-A424-2	
5	Screw-mounting	DIP pin	—	XS2M-D524-1	—	
		Solder cup pin	AWG20 to 28	XS2M-D524-2	—	

Metal Body

No. of poles	Mounting method	Pin shape*1	Applicable wire diameter	DC	UL
				Model	
4	Screw-mounting	DIP pin	—	XS2M-D424-3	—
		Solder cup pin	AWG20 to 28	XS2M-D424-4	
5		DIP pin	—	XS2M-D524-3	
		Solder cup pin	AWG20 to 28	XS2M-D524-4	

*1. The solder cup pin is for wire mounting, and the DIP pin is for PCB mounting.
Soldering is required for both pins.

Dimensions

(Unit: mm)

Flange-mounting XS2M-D423 (For DC) XS2M-A423 (For AC)

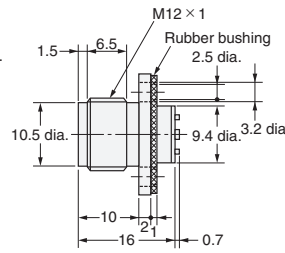
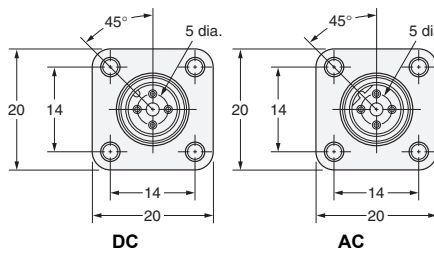

Panel Cutouts

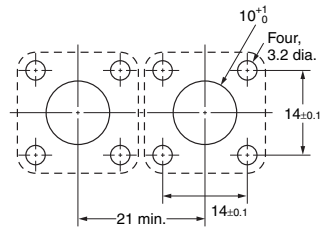

Screw-mounting XS2M-□424-1 DIP pin (Resin Body) XS2M-D424-3 DIP pin (Metal Body)

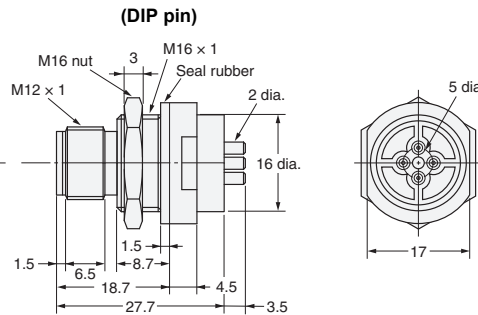
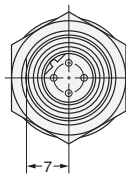
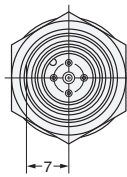
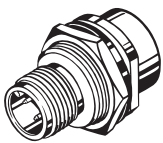

Panel Cutout

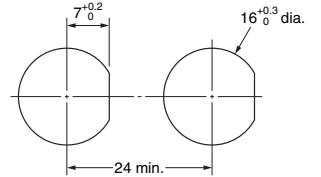

Note: The panel thickness is 1 to 4 mm.

PCB-mounting Dimensions

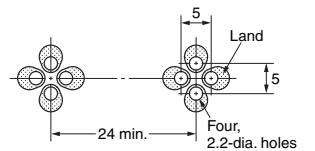

Screw-mounting

XS2M-□424-2 Solder Cup Pins (Resin Body)

XS2M-D424-4 Solder Cup Pins (Metal Body)

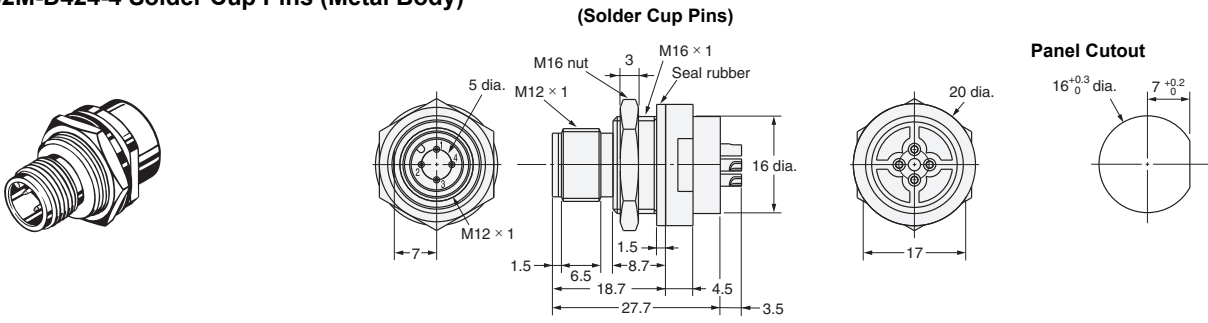

Screw-mounting

XS2M-D524-1 DIP pin (Resin Body)

Panel Cutout

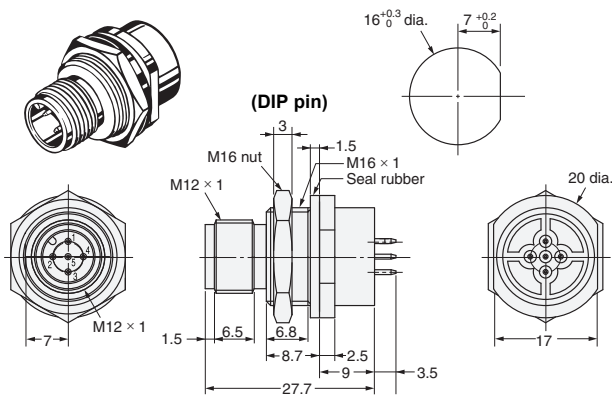

Screw-mounting

XS2M-D524-2 Solder Cup Pins (Resin Body)

Panel Cutout

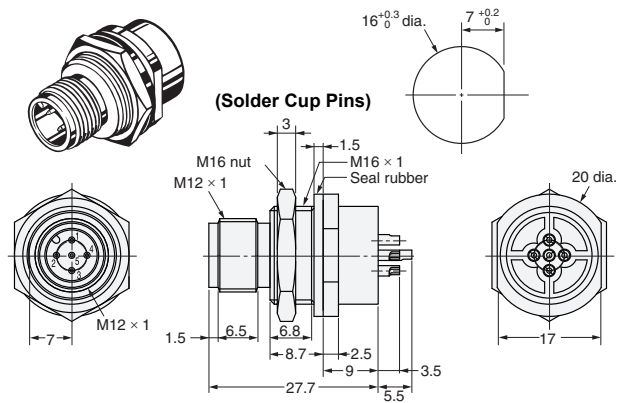

Screw-mounting

XS2M-D524-3 DIP pin (Metal Body)

Panel Cutout

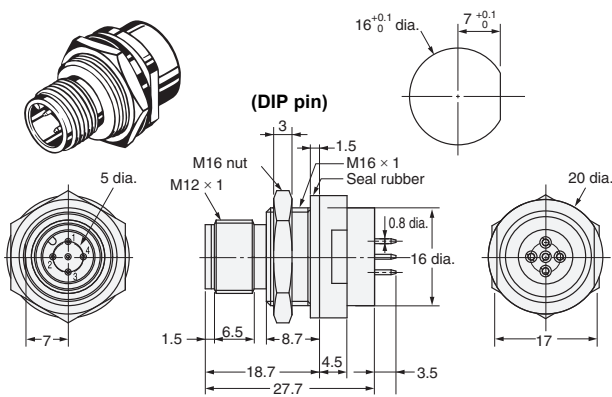

Screw-mounting

XS2M-D524-4 Solder Cup Pins (Metal Body)

Panel Cutout

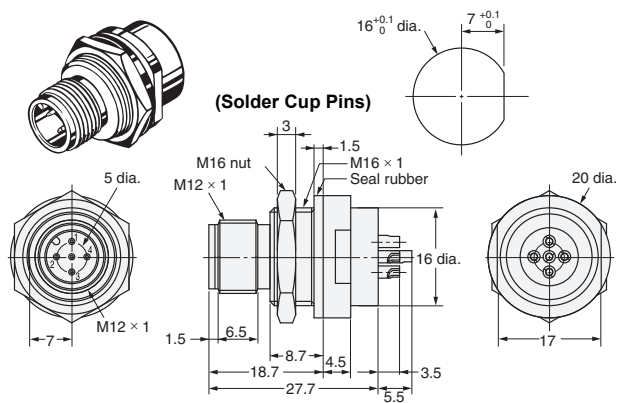

Common Accessories and Tools (Order Separately)

Ordering Information

Connector Covers

Waterproof Covers

XS2Z-11

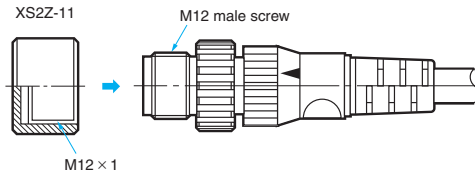
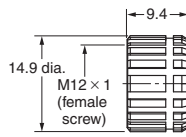

Application Example: XS2Z-11



You can use the Waterproof Cover when the connector is not connected to ensure an IP67 degree of protection. When mounting the Water-resistant Cover to a Connector, be sure to apply a torque range between 0.39 and 0.49 N·m to tighten the Water-resistant Cover.

XS2Z-22

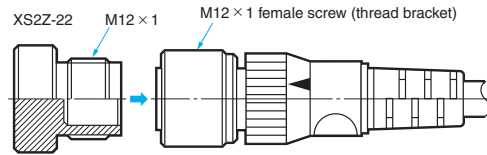
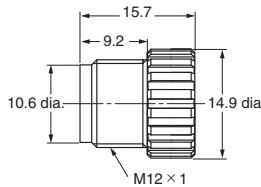

Model	Materials	Suitable connector	
		Model	Mounting portion
XS2Z-11	Copper alloy/ Nickel plated	XS2G/XS2H/XS2M/XS2R/XS2W/XS5H/ XS5M/XS5W	M12 male screw
XS2Z-22		XS2C/XS2R/XS2F/XS2P/XS2W/XW3B/ XS5F/XS5W/XS5R/XS5P/XW3D	M12 female screw (thread bracket)

Dust Covers

XS2Z-13

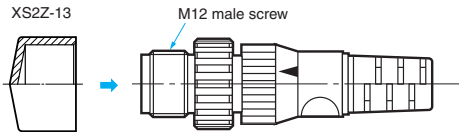

Application Example: XS2Z-13



XS2Z-15/XS2Z-14

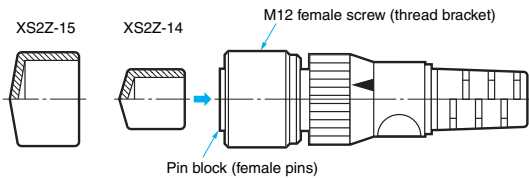

The Dust Cover is for dust prevention and does not ensure IP67 degree of protection. When mounting the Dust Cover to a Connector, be sure to press the Dust Cover onto the Connector until the Connector is fully inserted into the Dust Cover.

Model	Materials	Suitable connector	
		Model	Mounting portion
XS2Z-13	Rubber/black	XS2G/XS2H/XS2M/XS2R	M12 male screw
XS2Z-14		XS2C/XS2R/XS2F/XS2P/XW3B	Pin block (female pins)
XS2Z-15			M12 female screw (thread bracket)

Loosening-preventing C-ring

XS2Z-18



Application Example: XS2Z-18

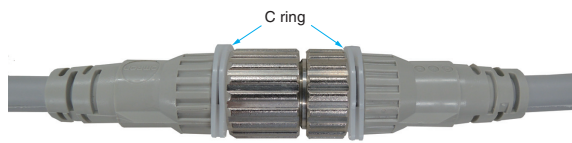

Note: Attach C-rings to both the plug and socket.

This C-ring prevents the M12 connector from becoming loose. When you attach the C-ring, press it securely between the thread bracket and cover.

Model	Materials	Suitable connector
XS2Z-18	POM	XS2F/H/W

Sputter Protective Cover

XS2Z-31

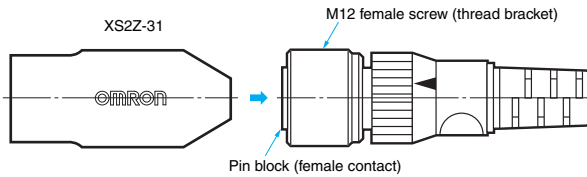
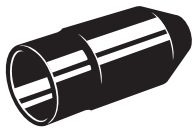

Application Example: XS2Z-31



The Sputter Protective Cover protects the connector from weld sputter. Make sure it covers the entire connector.

Model	Materials	Suitable connector
XS2Z-31	Silicone rubber/black	XS5F/XS5H/XS5W/ XS2F/XS2H/XS2W

Tools

Torque Wrench

XY2F-0004

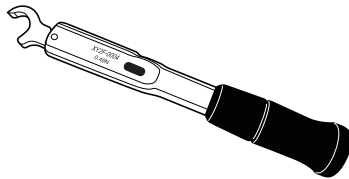

Crimp Tool

XY2F-0002

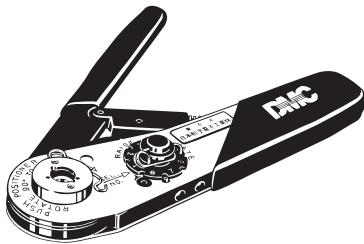

Locator

XY2F-0003

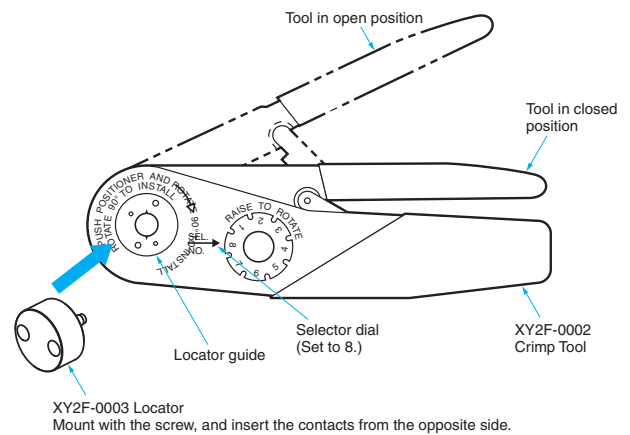

Use the Crimp Tool to crimp a cable core to the XS2U Crimping Pin used with the XS2C or XS2G Crimping Connector. Both the Crimp Tool and the optional Locator are required for use.

- The XY2F-0002 Crimp Tool is DMC's AFM8 (M22520/2-01).
- The XY2F-0003 Locator is a component for positioning crimp terminals. Use the screw provided to mount the Locator to the locator guide of the Crimp Tool.

Pin-block Extraction Tool

XY2F-0001

Use this tool to extract a Pin Block from the covers in order to make wiring changes or corrections after the cover has been mounted to the pin block for Connector Assemblies (XS2C/ XS2G, soldering/crimping).

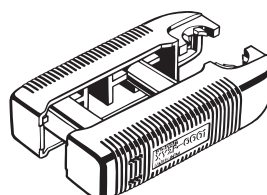

Safety Precautions

Extraction Procedure

(1) Disconnecting Components

- Disconnect all components on the cap side from the cover.

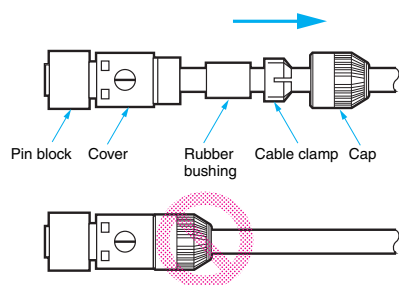

(2) Extracting Pin Block

- Insert the claws of the Tool into the four holes of the cover.

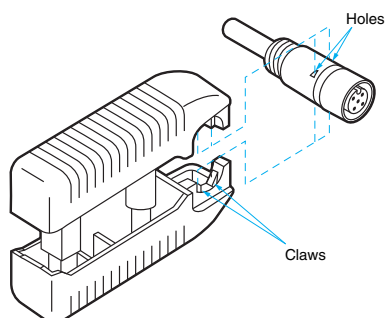

- Make sure that the pin block is outside the Tool.

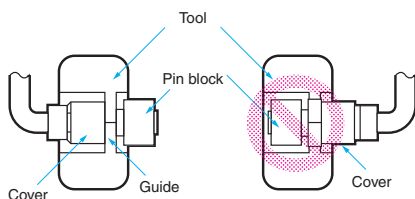

- Press the Tool so that the guides of the Tool are in close contact. Then pull the pin block straight.

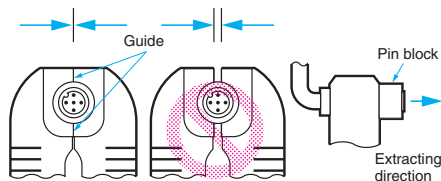

Precautions for Correct Use

- The pin block must not be extracted from the same Connector more than 3 times, otherwise the proper degree of protection of the pin block or Connector will not be maintained.
- Do not use the product in atmospheres or environments that exceed product ratings.

Tightening Cap (Connector Assemblies)

- 1) Do not use pliers to tighten caps, otherwise the caps may be damaged. Use your fingers to tighten the Connectors sufficiently. (0.39 to 0.49 N·m)
- 2) If caps are not tightened securely, the Connectors may not maintain their proper degree of protection (i.e., IP67) or the caps may become loose due to vibration.

Connector Connection and Disconnection

- When connecting or disconnecting Connectors, be sure to hold the Connectors by hand.
- Do not hold the cable when disconnecting Connectors.
- Connectors mating with sockets must be fully inserted into the mating sections. Tighten the thread bracket carefully so that the threads will not be damaged.
- Fully tighten thread bracket within a torque range between 0.39 and 0.49 N·m and be sure that the threads of the opposite parts are hidden by the thread bracket.
- When disconnecting Connectors, be sure to loosen the thread brackets first. Do not loosen the caps.
- Thread brackets must be loosened in the cutout direction.

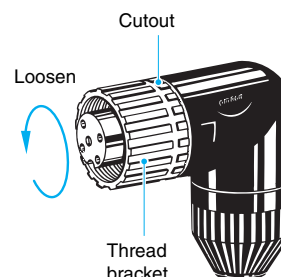

Degree of Protection

- Do not impose external force continuously on the joints of pin blocks and covers, otherwise the Connectors may not keep its proper degree of protection (i.e., IP67).
- The degree of protection of connectors (IP67) is not for a fully watertight structure. Do not use them underwater.
- Connectors are of resin mold construction. Do not impose excessive force on them.

Setup

- Do not make any cable bends near the base of the Unit.
- Any bends made must have a minimum radius of 40 mm.

Terms and Conditions Agreement

Read and understand this catalog.

Please read and understand this catalog before purchasing the products. Please consult your OMRON representative if you have any questions or comments.

Warranties.

(a) Exclusive Warranty. Omron's exclusive warranty is that the Products will be free from defects in materials and workmanship for a period of twelve months from the date of sale by Omron (or such other period expressed in writing by Omron). Omron disclaims all other warranties, express or implied.

(b) Limitations. OMRON MAKES NO WARRANTY OR REPRESENTATION, EXPRESS OR IMPLIED, ABOUT NON-INFRINGEMENT, MERCHANTABILITY OR FITNESS FOR A PARTICULAR PURPOSE OF THE PRODUCTS. BUYER ACKNOWLEDGES THAT IT ALONE HAS DETERMINED THAT THE PRODUCTS WILL SUITABLY MEET THE REQUIREMENTS OF THEIR INTENDED USE.

Omron further disclaims all warranties and responsibility of any type for claims or expenses based on infringement by the Products or otherwise of any intellectual property right. (c) Buyer Remedy. Omron's sole obligation hereunder shall be, at Omron's election, to (i) replace (in the form originally shipped with Buyer responsible for labor charges for removal or replacement thereof) the non-complying Product, (ii) repair the non-complying Product, or (iii) repay or credit Buyer an amount equal to the purchase price of the non-complying Product; provided that in no event shall Omron be responsible for warranty, repair, indemnity or any other claims or expenses regarding the Products unless Omron's analysis confirms that the Products were properly handled, stored, installed and maintained and not subject to contamination, abuse, misuse or inappropriate modification. Return of any Products by Buyer must be approved in writing by Omron before shipment. Omron Companies shall not be liable for the suitability or unsuitability or the results from the use of Products in combination with any electrical or electronic components, circuits, system assemblies or any other materials or substances or environments. Any advice, recommendations or information given orally or in writing, are not to be construed as an amendment or addition to the above warranty.

See <http://www.omron.com/global/> or contact your Omron representative for published information.

Limitation on Liability: Etc.

OMRON COMPANIES SHALL NOT BE LIABLE FOR SPECIAL, INDIRECT, INCIDENTAL, OR CONSEQUENTIAL DAMAGES, LOSS OF PROFITS OR PRODUCTION OR COMMERCIAL LOSS IN ANY WAY CONNECTED WITH THE PRODUCTS, WHETHER SUCH CLAIM IS BASED IN CONTRACT, WARRANTY, NEGLIGENCE OR STRICT LIABILITY.

Further, in no event shall liability of Omron Companies exceed the individual price of the Product on which liability is asserted.

Suitability of Use.

Omron Companies shall not be responsible for conformity with any standards, codes or regulations which apply to the combination of the Product in the Buyer's application or use of the Product. At Buyer's request, Omron will provide applicable third party certification documents identifying ratings and limitations of use which apply to the Product. This information by itself is not sufficient for a complete determination of the suitability of the Product in combination with the end product, machine, system, or other application or use. Buyer shall be solely responsible for determining appropriateness of the particular Product with respect to Buyer's application, product or system. Buyer shall take application responsibility in all cases.

NEVER USE THE PRODUCT FOR AN APPLICATION INVOLVING SERIOUS RISK TO LIFE OR PROPERTY OR IN LARGE QUANTITIES WITHOUT ENSURING THAT THE SYSTEM AS A WHOLE HAS BEEN DESIGNED TO ADDRESS THE RISKS, AND THAT THE OMRON PRODUCT(S) IS PROPERLY RATED AND INSTALLED FOR THE INTENDED USE WITHIN THE OVERALL EQUIPMENT OR SYSTEM.

Programmable Products.

Omron Companies shall not be responsible for the user's programming of a programmable Product, or any consequence thereof.

Performance Data.

Data presented in Omron Company websites, catalogs and other materials is provided as a guide for the user in determining suitability and does not constitute a warranty. It may represent the result of Omron's test conditions, and the user must correlate it to actual application requirements. Actual performance is subject to the Omron's Warranty and Limitations of Liability.

Change in Specifications.

Product specifications and accessories may be changed at any time based on improvements and other reasons. It is our practice to change part numbers when published ratings or features are changed, or when significant construction changes are made. However, some specifications of the Product may be changed without any notice. When in doubt, special part numbers may be assigned to fix or establish key specifications for your application. Please consult with your Omron's representative at any time to confirm actual specifications of purchased Product.

Errors and Omissions.

Information presented by Omron Companies has been checked and is believed to be accurate; however, no responsibility is assumed for clerical, typographical or proofreading errors or omissions.

2023.1

In the interest of product improvement, specifications are subject to change without notice.

OMRON Corporation
Industrial Automation Company

<http://www.ia.omron.com/>

(c)Copyright OMRON Corporation 2023 All Right Reserved.