





# Modular Type Filter Regulators *Series AW*

Filter Regulator Series AW	Model	Port size	Options
 <p>Page 67 through to 78</p>	AW10	M5	Bracket Float type auto drain Square embedded type pressure gauge (except the AW10) Round type pressure gauge Digital pressure switch (except the AW10) Panel mount
	AW20	1/8, 1/4	
	AW30	1/4, 3/8	
	AW40	1/4, 3/8, 1/2	
	AW40-06	3/4	
	AW60	3/4, 1	
 <p>Page 67 through to 78</p>	AW20K	1/8, 1/4	
	AW30K	1/4, 3/8	
	AW40K	1/4, 3/8, 1/2	
	AW40K-06	3/4	
	AW60K	3/4, 1	
 <p>Page 79 through to 88</p>	AWM20	1/8, 1/4	
	AWM30	1/4, 3/8	
	AWM40	1/4, 3/8, 1/2	
 <p>Page 79 through to 88</p>	AWD20	1/8, 1/4	
	AWD30	1/4, 3/8	
	AWD40	1/4, 3/8, 1/2	

# Filter Regulator

# AW10 to AW60

## Filter Regulator with Backflow Function

# AW20K to AW60K

JIS Symbol  
Filter Regulator

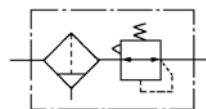

Filter Regulator with  
Backflow Function

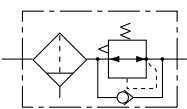

- Integrated filter and regulator units save space and require less piping.
- With the backflow function it incorporates a mechanism to exhaust the air pressure in the outlet side reliably and quickly.

Example)

When the air supply is cut off and releasing the inlet pressure to the atmosphere, the residual pressure release of the outlet side can be ensured for a safety purpose.

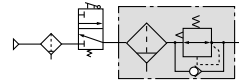

## How to Order

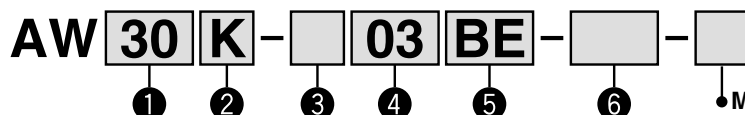

• **Made to Order**

Refer to page 75 through to 78 for details.

- Option/Semi-standard: Select one each for a to i.
- Option/Semi-standard symbol: When more than one specification is required, indicate in ascending alphanumeric order.  
Example) AW30K-03BE-1N

	Symbol	Description	①						
			Body size						
			10	20	30	40	60		
②	—	Without backflow function	●	●	●	●	●		
	<b>K</b> (Note 1)	With backflow function	—	●	●	●	●		
③	+								
	—	Metric thread (M5)	●	—	—	—	—		
	<b>N</b> (Note 2)	Rc	—	●	●	●	●		
	<b>F</b> (Note 3)	NPT	—	●	●	●	●		
④	+								
	<b>M5</b>	M5	●	—	—	—	—		
	<b>01</b>	1/8	—	●	—	—	—		
	<b>02</b>	1/4	—	●	●	—	—		
	<b>03</b>	3/8	—	—	●	●	—		
	<b>04</b>	1/2	—	—	—	●	—		
	<b>06</b>	3/4	—	—	—	●	●		
⑤	+								
	a	—	Without mounting option	●	●	●	●	●	
		<b>B</b> (Note 5)	With bracket	●	●	●	●	●	
		<b>H</b>	With set nut (for panel fitting)	●	●	●	●	—	
	b	+							
		—	Without auto drain	●	●	●	●	●	
		<b>C</b>	Float type auto drain (N.C.)	●	●	●	●	●	
	c	<b>D</b>	Float type auto drain (N.O.)	—	—	●	●	●	
		+							
		—	Without pressure gauge	●	●	●	●	●	
			<b>E</b>	Square embedded type pressure gauge (with limit indicator)	—	●	●	●	●
			<b>G</b>	Round type pressure gauge (without limit indicator)	●	—	—	—	—
Round type pressure gauge (with limit indicator)				—	●	●	●	●	
<b>M</b>		Round type pressure gauge (with colour zone)	—	●	●	●	●		
		<b>E1</b> (Note 6)	Output: NPN output / Electrical entry: Wiring bottom entry	—	●	●	●	●	
	<b>E2</b> (Note 6)		Output: NPN output / Electrical entry: Wiring top entry	—	●	●	●	●	
			Output: PNP output / Electrical entry: Wiring bottom entry	—	●	●	●	●	
<b>E4</b> (Note 6)	Output: PNP output / Electrical entry: Wiring top entry		—	●	●	●	●		
	⑥	+							
d		— (Note 7)	0.05 to 0.85 MPa setting	●	●	●	●	●	
		<b>1</b> (Note 8)	0.02 to 0.2 MPa setting	●	●	●	●	●	
e	+								
	—	Polycarbonate bowl	●	●	●	●	●		
		<b>2</b>	Metal bowl	●	●	●	●	●	
		<b>6</b>	Nylon bowl	●	●	●	●	●	
		<b>8</b>	Metal bowl with level gauge	—	—	●	●	●	
		<b>C</b>	With bowl guard	—	●	—	—	—	
<b>6C</b>		Nylon bowl with bowl guard	—	●	—	—	—		

# Filter Regulator *Series AW10 to AW60*

## Filter Regulator with Backflow Function *Series AW20K to AW60K*



AW20, AW20K AW40, AW40K

		Symbol	Description	①					
				Body size					
				10	20	30	40	60	
⑥	f	—	With drain cock	●	●	●	●	●	
			J <sup>Note 10</sup>	Drain guide 1/8	—	●	—	—	—
			—	Drain guide 1/4	—	—	●	●	●
			W <sup>Note 11</sup>	Drain cock with barb fitting: For ø6 x ø4 nylon tube	—	—	●	●	●
			+						
	g	—	Relieving type	●	●	●	●	●	
			N	Non-relieving type	●	●	●	●	●
			+						
	h	—	Flow direction: Left to right	●	●	●	●	●	
			R	Flow direction: Right to left	●	●	●	●	●
			+						
	i	—	Name plate, caution plate for bowl, and pressure gauge in imperial units: MPa	●	●	●	●	●	
Z <sup>Note 12</sup>			Name plate, caution plate for bowl, and pressure gauge in imperial units: psi, F	○ <sup>Note 14</sup>	○ <sup>Note 14</sup>	○ <sup>Note 14</sup>	○ <sup>Note 14</sup>	○ <sup>Note 14</sup>	
ZA <sup>Note 13</sup>			Digital pressure switch: With unit conversion function	—	△ <sup>Note 15</sup>	△ <sup>Note 15</sup>	△ <sup>Note 15</sup>	△ <sup>Note 15</sup>	

Note 1) The AW10 type comes with a backflow function as a standard feature. (K is not available.) When using the AW10 type as w/ backflow function, backflow may not occur with the set pressure 0.15 MPa or less. Please set the inlet pressure to at least 0.05 MPa higher than the set pressure.

Note 2) Drain guide is NPT1/8 (applicable to the AW20(K)) and NPT1/4 (applicable to the AW30(K) to AW60(K)). The auto drain port comes with ø3/8" one-touch fitting (applicable to the AW30(K) to AW60(K)).

Note 3) Drain guide is G1/8 (applicable to the AW20(K)) and G1/4 (applicable to the AW30(K) to AW60(K)).

Note 4) Option B, G, H and M are not assembled and supplied loose at the time of shipment.

Note 5) Assembly of a bracket and set nuts (AW10, AW20(K) to AW40(K)) Includes 2 mounting screws for the AW60(K)

Note 6) When choosing with H (panel mount), the installation space for lead wires will be limited. In this case, select "wiring top entry" for the electrical entry.

Note 7) Only the AW10 has a pressure setting of 0.05 to 0.7 MPa.

Note 8) The only difference from the standard specifications is the adjusting spring for the regulator. It does not restrict the setting of 0.2 MPa or more. When the pressure gauge is attached, a 0.2 MPa pressure gauge will be fitted.

Note 9) Float type auto drain: The combination between C or D is not available with the drain port options.

Note 10) Without a valve function

Note 11) Metal bowl: The combination of 2 cannot be selected with W.

Note 12) For thread type: M5 and NPT. This product is for overseas use only according to the new Measurement Law. (The SI unit type is provided for use in Japan.) The digital pressure switch will be equipped with the unit conversion function, setting to psi initially.

Note 13) For options: E1, E2, E3, E4. This product is for overseas use only according to the new Measurement Law. (The SI unit is provided for use in Japan.)

Note 14) ○: For thread type: M5 and NPT only

Note 15) △: Select with options: E1, E2, E3, E4.

### Standard Specifications

Model	AW10	AW20(K)	AW30(K)	AW40(K)	AW40(K)-06	AW60(K)
Port size	M5 x 0.8	1/8, 1/4	1/4, 3/8	1/4, 3/8, 1/2	3/4	3/4, 1
Pressure gauge port size <sup>Note 1)</sup>	1/16 <sup>Note 2)</sup>	1/8		1/4		
Fluid	Air					
Ambient and fluid temperature <sup>Note 3)</sup>	-5 to 60°C (with no freezing)					
Proof pressure	1.5 MPa					
Maximum operating pressure	1.0 MPa					
Set pressure range	0.05 to 0.7 MPa	0.05 to 0.85 MPa				
Relief pressure <sup>Note 4)</sup>	Set pressure + 0.05 MPa [at relief flow rate of 0.1 l/min (ANR)]					
Nominal filtration rating	5 µm					
Drain capacity (cm <sup>3</sup> )	2.5	8	25	45	45	45
Bowl material	Polycarbonate					
Bowl guard	—	Semi-standard	Standard			
Construction	Relieving type					
Mass (kg)	0.09	0.20	0.40	0.72	0.75	2.00

Note 1) Pressure gauge connection threads are not available for F.R.L. unit with a square embedded type pressure gauge (AW20(K) to AW60(K)).

Note 2) Use a bushing (part no:131368) when connecting the R1/8 pressure gauge to the Rc1/16.

Note 3) -5 to 50°C for the products with the digital pressure switch  
Note 4) Not applicable to the AW10.

# Series AW10 to AW60

# Series AW20K to AW60K

## Options/Part No.

Optional specifications			Model					
			AW10(K)	AW20(K)	AW30(K)	AW40(K)	AW40(K)-06	AW60(K)
<b>Bracket assembly</b> <sup>Note 1)</sup>			AR10P-270AS	AW20P-270AS	AR30P-270AS	AR40P-270AS		AW60P-270AS <sup>Note 6)</sup>
<b>Set nut</b>			AR10P-260S	AR20P-260S	AR30P-260S	AR40P-260S		— <sup>Note 7)</sup>
<b>Pressure gauge</b>	<b>Round type</b> <sup>Note 2)</sup>	<b>Standard</b>	G27-10-R1	G36-10-□01		G46-10-□02		
		<b>0.02 to 0.2 MPa setting</b>	G27-10-R1 <sup>Note 3)</sup>	G36-2-□01		G46-2-□02		
	<b>Round type (with colour zone)</b> <sup>Note 2)</sup>	<b>Standard</b>	—	G36-10-□01-L		G46-10-□02-L		
		<b>0.02 to 0.2 MPa setting</b>	—	G36-2-□01-L		G46-2-□02-L		
<b>Square embedded type</b> <sup>Note 4)</sup>	<b>Standard</b>	—	GC3-10AS [GC3P-010AS (Pressure gauge cover only)]					
	<b>0.02 to 0.2 MPa setting</b>	—	GC3-2AS [GC3P-010AS (Pressure gauge cover only)]					
<b>Digital pressure switch</b> <sup>Note 5)</sup>	NPN output / Wiring bottom entry		—	ISE35-N-25-MLA [ISE35-N-25-M (Switch body only)]				
	NPN output / Wiring top entry			ISE35-R-25-MLA [ISE35-R-25-M (Switch body only)]				
	PNP output / Wiring bottom entry			ISE35-N-65-MLA [ISE35-N-65-M (Switch body only)]				
	PNP output / Wiring top entry			ISE35-R-65-MLA [ISE35-R-65-M (Switch body only)]				
<b>Float type auto drain</b> <sup>Note 8) Note 9)</sup>			<b>N.C.</b>	AD17	AD27	AD37	AD47	
			<b>N.O.</b>	—	—	AD38	AD48	

## Semi-standard/Bowl Assembly Part No.

Semi-standard specifications						Model					
Bowl material	<sup>Note 8) Note 9)</sup> Float type auto drain		<sup>Note 9)</sup> With drain guide	With barb fitting	With bowl guard	AW10(K)	AW20(K)	AW30(K)	AW40(K)	AW40(K)-06	AW60(K)
	N.C.	N.O.									
Polycarbonate	—	—	—	—	●	—	C2SF-C	—	—		
	●	—	—	—	●	—	AD27-C	—	—		
	—	—	●	—	—	—	C2SF-J	C3SF-J	C4SF-J		
	—	—	—	●	—	—	—	C3SF-W	C4SF-W		
	—	—	●	—	●	—	C2SF-CJ	—	—		
Nylon	—	—	—	—	—	C1SF-6	C2SF-6	C3SF-6	C4SF-6		
	—	—	—	—	●	—	C2SF-6C	—	—		
	●	—	—	—	—	AD17-6	AD27-6	AD37-6	AD47-6		
	—	●	—	—	—	—	—	AD38-6	AD48-6		
	●	—	—	—	●	—	AD27-6C	—	—		
	—	—	●	—	—	—	C2SF-6J	C3SF-6J	C4SF-6J		
	—	—	—	●	—	—	—	C3SF-6W	C4SF-6W		
Metal	—	—	—	—	—	C1SF-2	C2SF-2	C3SF-2	C4SF-2		
	●	—	—	—	—	AD17-2	AD27-2	AD37-2	AD47-2		
	—	●	—	—	—	—	—	AD38-2	AD48-2		
	—	—	●	—	—	—	C2SF-2J	C3SF-2J	C4SF-2J		
Metal bowl with level gauge	—	—	—	—	—	—	—	C3LF-8	C4LF-8		
	●	—	—	—	—	—	—	AD37-8	AD47-8		
	—	●	—	—	—	—	—	AD38-8	AD48-8		
	—	—	●	—	—	—	—	C3LF-8J	C4LF-8J		

Note 1) Assembly includes a bracket and set nuts

Note 2) □ in part numbers for a round pressure gauge indicates a type of connection thread. No indication is necessary for R; however, indicate N for NPT. Please contact SMC regarding the connection thread NPT and pressure gauge supply for psi unit specifications.

Note 3) Standard pressure gauge

Note 4) Including one O-ring and 2 mounting screws. [ ]: Pressure gauge cover only

Note 5) Lead wire with connector (2 m), adapter, lock pin, O-ring (1 pc.), mounting screw (2 pcs.) are attached. [ ]: Switch body only. Also, regarding how to order the digital pressure switch, please refer to page 89. A pressure switch adapter assembly (AW60P-310AS) will be additionally required for the AW60(K) only. Use the attached mounting screw (M3 x 0.5 x 14) for mounting. The mounting screw (M3 x 0.5 x 7) attached to the digital pressure switch assembly will not be required.

Note 6) Assembly of a bracket and 2 mounting screws

Note 7) Please consult SMC regarding the set nuts for the AW60(K).

Note 8) Minimum operating pressure: N.O. type—0.1 MPa; N.C. type—0.1 MPa (AD27) and 0.15 MPa (AD37/47). Please contact SMC for psi and °F unit specifications.

Note 9) Please consult SMC for details on drain piping to fit NPT or G port sizes.

Note) • Bowl O-ring is included for the AW20(K) to AW60(K).

• Bowl assembly for the AW30(K) to AW60(K) models comes with a bowl guard (steel band material). (except when the bowl material is metal)



# Series AW10 to AW60 Series AW20K to AW60K Specific Product Precautions

Be sure to read this before handling. Refer to “Precautions for Handling Pneumatic Devices” (M-03-E3A) for Safety Instructions and F.R.L. Units Precautions.

## Selection

### Warning

1. Residual pressure disposal (outlet pressure removal) is not possible for the AW20 to AW60 even though the inlet pressure is exhausted. When the residual pressure disposal is performed, use the filter regulator with backflow function (AW20K to AW60K).

## Maintenance

### Warning

1. Replace the element every 2 years or when the pressure drop becomes 0.1 MPa, whichever comes first, to prevent damage to the element.

## Mounting and Adjustment

### Warning

1. Set the regulator while verifying the displayed values of the inlet and outlet pressure gauges. Turning the regulator knob excessively can cause damage to the internal parts.
2. The pressure gauge included with regulators for 0.02 to 0.2 MPa setting is for up to 0.2 MPa use only (except the AW10). Exceeding 0.2 MPa of pressure can damage the gauge.
3. Do not use tools on the pressure regulator knob as this may cause damage. It must be operated manually.

### Caution

1. Be sure to unlock the knob before adjusting the pressure and lock it after setting the pressure. Failure to follow this procedure can cause damage to the knob and the outlet pressure may fluctuate.
  - Pull the pressure regulator knob to unlock. (You can visually verify this with the “orange mark” that appears in the gap.)
  - Push the pressure regulator knob to lock. When the knob is not easily locked, turn it left and right a little and then push it (when the knob is locked, the “orange mark”, i.e., the gap will disappear).



2. A knob cover is available to prevent careless operation of the knob. Refer to page 90 for details.

# Series AW10 to AW60

## Series AW20K to AW60K

### Flow Characteristics (Representative values)

Condition: Inlet pressure 0.7 MPa

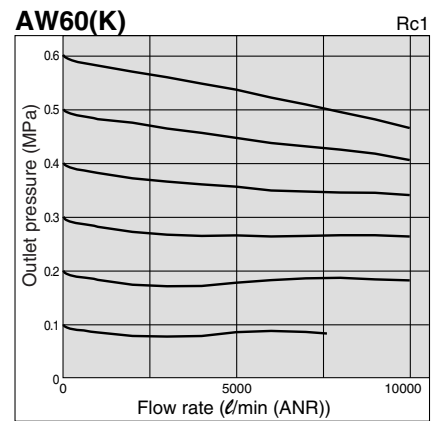
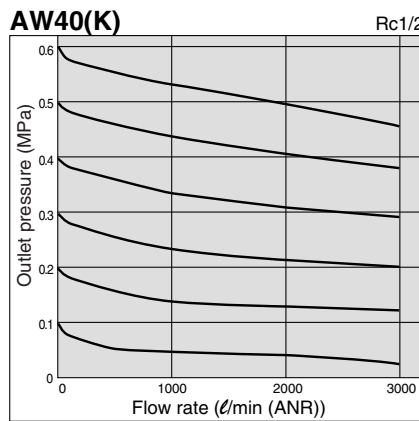
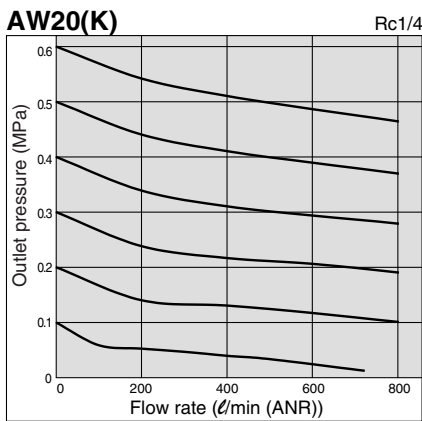
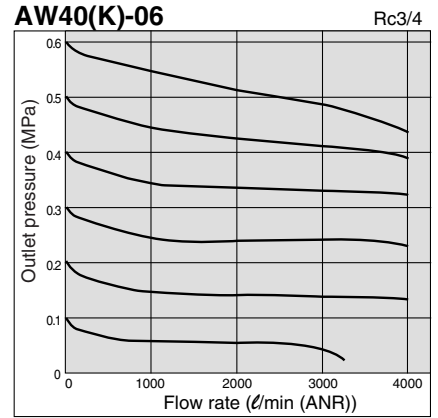
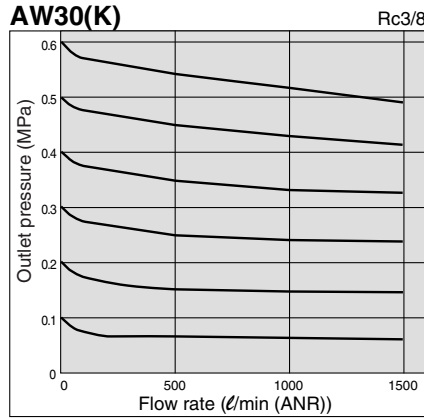
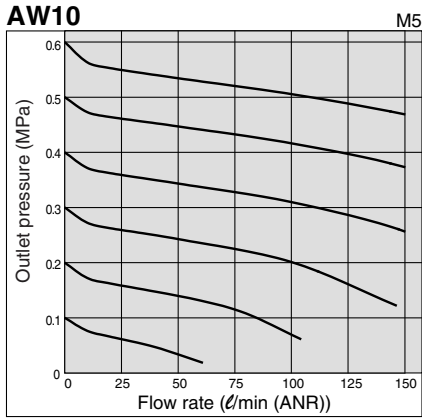

### Pressure Characteristics (Representative values)

Conditions: Inlet pressure 0.7 MPa, Outlet pressure 0.2 MPa, Flow rate 20 l/min (ANR)

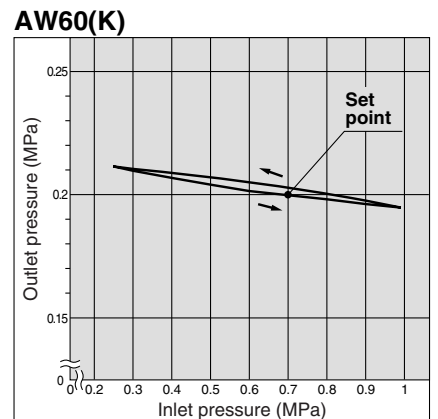
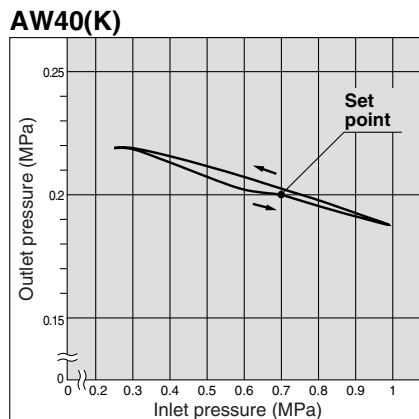
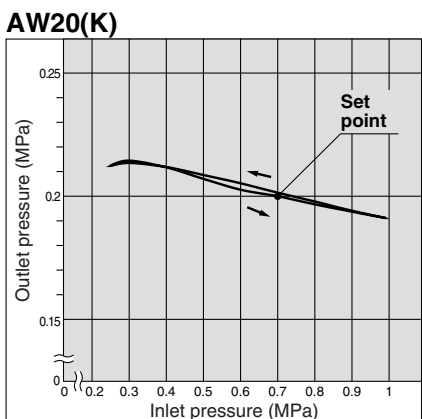
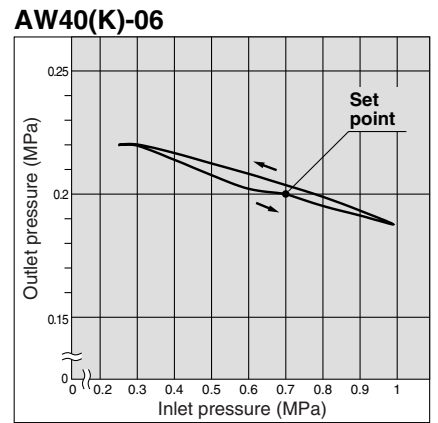
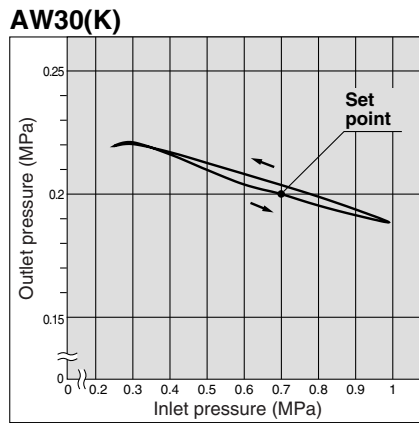
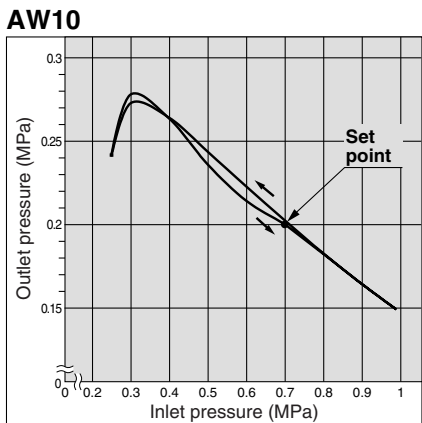

## Construction

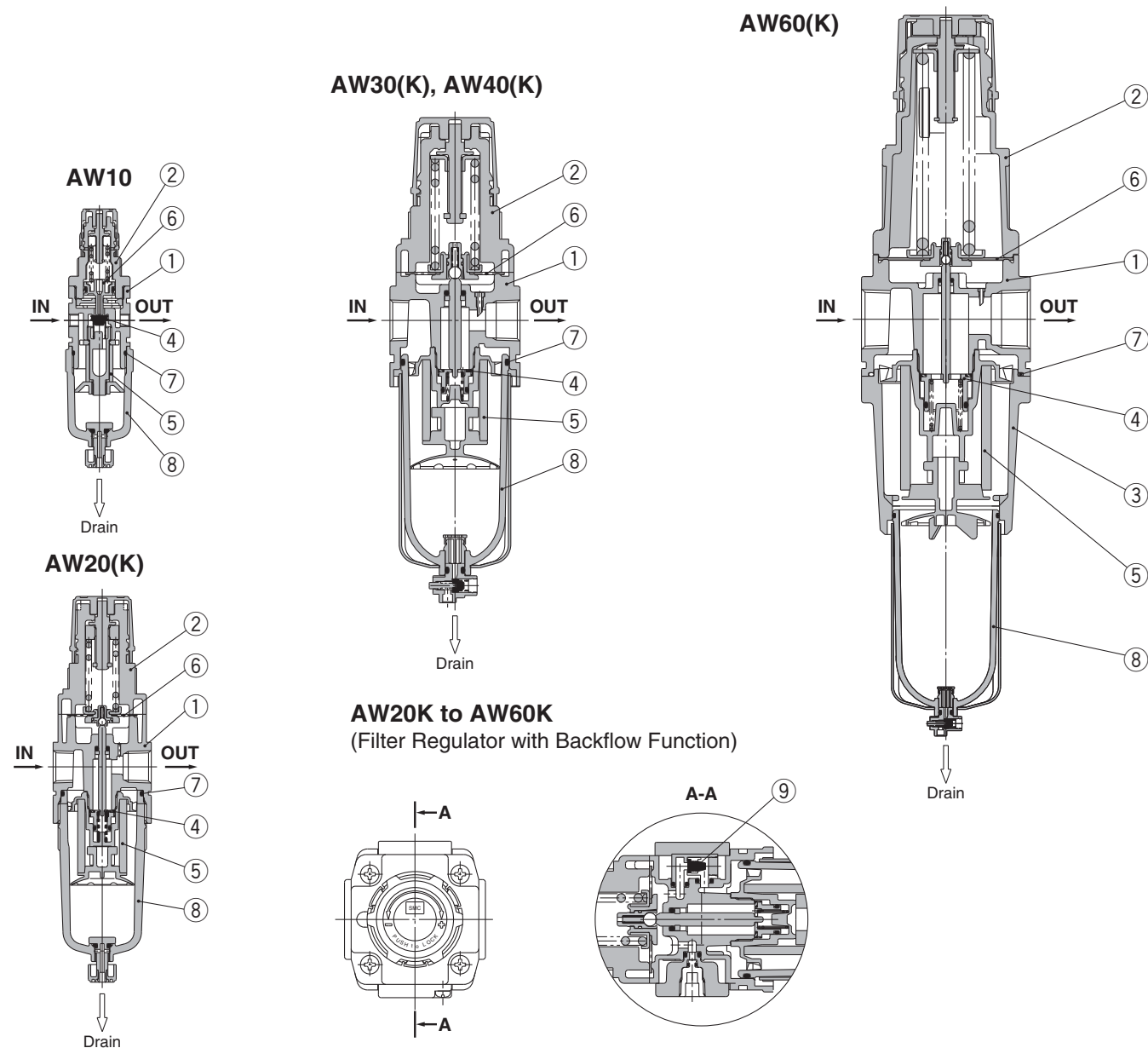

### Component Parts

No.	Description	Material	Model	Colour
1	Body	Zinc die-cast	AW10	Platinum silver
		Aluminum die-cast	AW20(K) to AW60(K)	
2	Bonnet	Polyacetal	AW10 to AW40(K)	Black
		Aluminum die-cast	AW60(K)	
3	Housing	Aluminum die-cast	AW60(K)	Platinum silver

### Replacement Parts

No.	Description	Material	Part no.					
			AW10	AW20(K)	AW30(K)	AW40(K)	AR40(K)-06	AW60(K)
4	Valve assembly	Brass, HNBR	AR10P-090S	AW20P-340AS	AW30P-340AS	AW40P-340AS	AW40P-380AS	AW60P-090AS
5	Filter element	Non-woven fabric	AF10P-060S	AF20P-060S	AF30P-060S	AF40P-060S		AW60P-060S
6	Diaphragm assembly	Weatherable NBR	AR10P-150AS <sup>Note 1)</sup>	AR20P-150AS	AR30P-150AS	AR40P-150AS		AR50P-150AS
7	Bowl O-ring	NBR	C1SFP-260S	C2SFP-260S	C3SFP-260S	C4SFP-260S		
8	Bowl assembly <sup>Note 2)</sup>	Polycarbonate	C1SF	C2SF	C3SF <sup>Note 3)</sup>	C4SF <sup>Note 3)</sup>		
9	Check valve assembly <sup>Note 4)</sup>	—	—	AR20KP-020AS				

Note 1) The AW10 is a piston type. Assembly of a piston and a seal (KSYP-13).

Note 2) Bowl O-ring is included for the AW20(K) to AW60(K). Please contact SMC regarding the bowl assembly supply for psi and °F unit specifications.

Note 3) Bowl assembly for the AW30(K) to AW60(K) models comes with a bowl guard (steel band material).

Note 4) Check valve assembly is applicable for a filter regulator with backflow function (AW20K to AW60K) only.

Assembly of a check valve cover, check valve body assembly and 2 screws



# Series AW10 to AW60

## Series AW20K to AW60K

### Working Principle (Filter Regulator with Backflow Function)

#### AW10

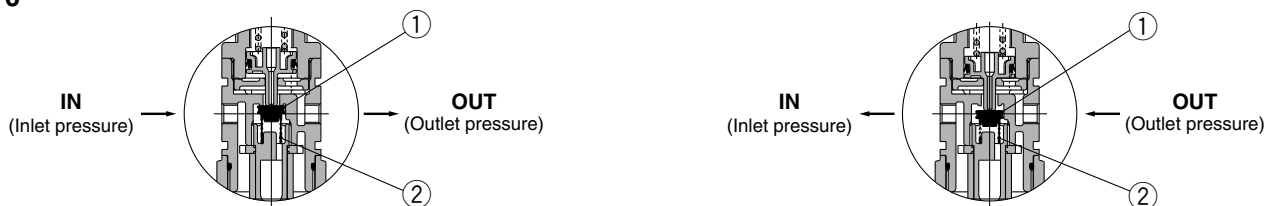

When the inlet pressure is higher than the regulating pressure, the check valve operates as a normal regulator (Figure 1).

When the inlet pressure is shut off and exhausted, any inlet pressure applied to valve ① will be lost. The force for seating valve ① is the valve spring ② force only. When the valve ① is opened using the outlet force, the outlet pressure will be exhausted at the inlet side. (Figure 2)

When the set pressure is 0.15 MPa or less, valve ① may not open due to the force of valve spring ②.

#### AW20K to AW60K

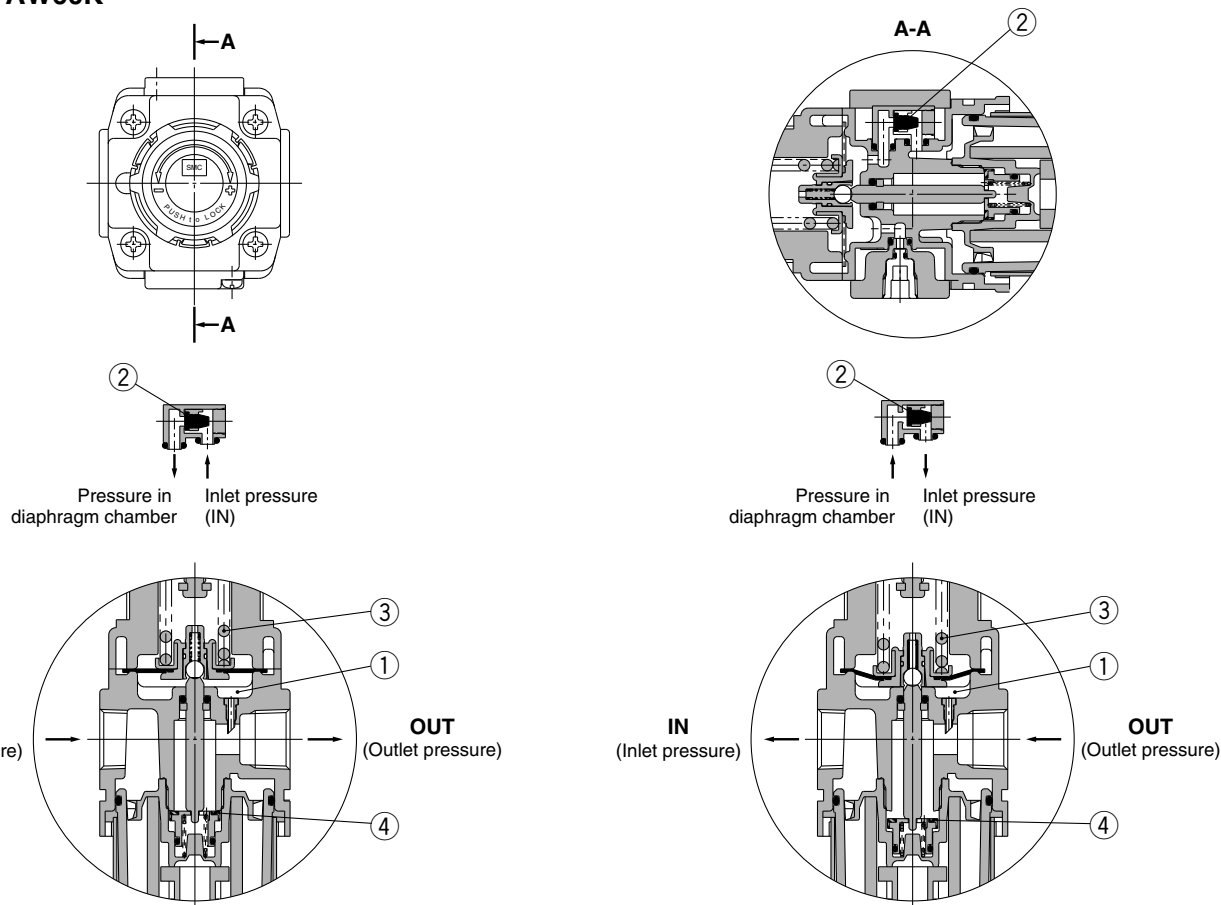

Figure 1 Normal

Figure 2 Backflow

When the inlet pressure is higher than the regulating pressure, check valve ② closes and operates as a normal regulator (Figure 1).

When the inlet pressure is shut off and released, check valve ② opens and the pressure in the diaphragm chamber ① is released into the inlet side (Figure 2).

This lowers the pressure in diaphragm chamber ① and the force generated by pressure regulator spring ③ lifts the diaphragm. Valve ④ opens through the stem, and the outlet pressure is released to the inlet side (Figure 2).



## Dimensions

### AW10, AW20(K)

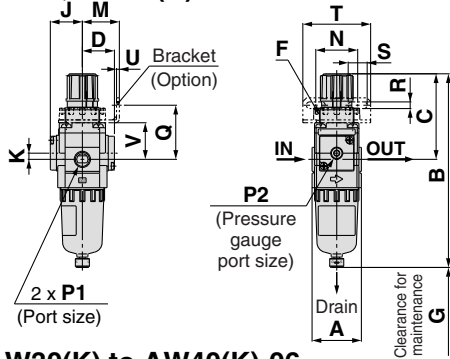

Panel fitting dimension

### AW60(K)

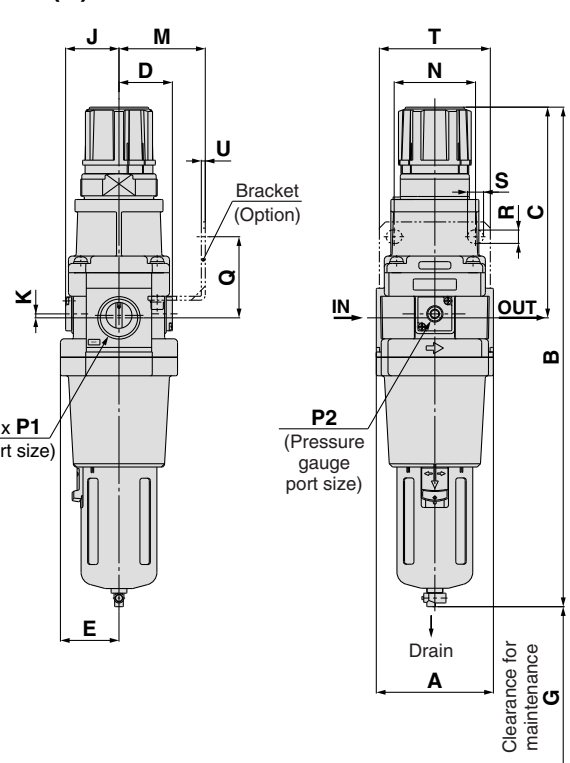
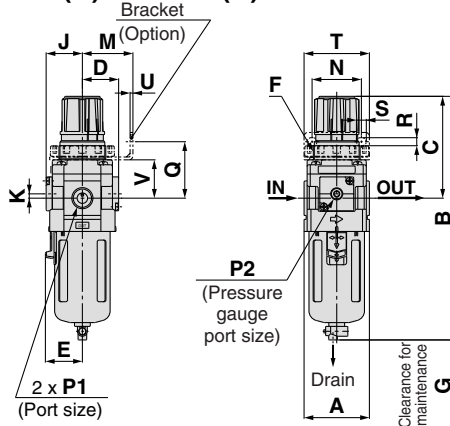

Plate thickness  
AW10, AW20(K): Max. 3.5

### AW30(K) to AW40(K)-06



Panel fitting dimension

Plate thickness  
AW30(K): Max. 3.5  
AW40(K): Max. 5

Applicable model	AW20(K) to AW60(K)		AW10, AW20(K) to AW60(K)	AW20(K) to AW60(K)
Option	Square embedded type pressure gauge	Digital pressure switch	Round type pressure gauge	Round type pressure gauge (with colour zone)
Dimensions				

Applicable model	AW10, AW20(K)		AW20(K)	AW30(K) to AW60(K)					
	Optional/Semi-standard specifications	With auto drain (N.C.)	Metal bowl	With drain guide	With auto drain (N.O./N.C.)	Metal bowl	Metal bowl with level gauge	With drain guide	Drain cock with barb fitting
Dimensions									

Model	Standard specifications											Optional specifications							
	P1	P2	A	B (Note)	C	D	E	F	G	J	K	H	J	H	J	H	J	H	J
AW10	M5	1/16	25	108	48	12.5	—	M18 x 1	25	13	0	—	—	—	—	ø26	26	—	—
AW20(K)	1/8, 1/4	1/8	40	160	73	26	—	M28 x 1	40	26	5	□28	27	□27.8	37.5	ø37.5	63	ø37.5	63
AW30(K)	1/4, 3/8	1/8	53	201	86	29.5	30	M38 x 1.5	55	29.5	3.5	□28	30.5	□27.8	41	ø37.5	66	ø37.5	66
AW40(K)	1/4, 3/8, 1/2	1/4	70	239	92	37.5	38	M42 x 1.5	80	37.5	1.5	□28	38.5	□27.8	49	ø42.5	76	ø42.5	76
AW40(K)-06	3/4	1/4	75	242	93	37.5	38	M42 x 1.5	80	37.5	1.2	□28	38.5	□27.8	49	ø42.5	76	ø42.5	76
AW60(K)	3/4, 1	1/4	95	409	175	43.5	47.5	—	20	43.5	3.2	□28	44.5	□27.8	61.5	ø42.5	84	ø42.5	84

Model	Optional specifications											Semi-standard specifications				
	Bracket mount					Panel mount						With auto drain	With barb fitting	With drain guide	Metal bowl	Metal bowl with level gauge
	M	N	Q	R	S	T	U	V	W	Y	Z	B (Note)	B (Note)	B (Note)	B (Note)	B (Note)
AW10	25	28	30	4.5	6.5	40	2	18	18.5	—	—	125	—	—	107	—
AW20(K)	30	34	44	5.4	15.4	55	2.3	30	28.5	14	6	177	—	164	160	—
AW30(K)	41	40	46	6.5	8	53	2.3	31	38.5	19	7	242	209	208	214	234
AW40(K)	50	54	54	8.5	10.5	70	2.3	35.5	42.5	21	7	278	247	246	252	272
AW40(K)-06	50	54	56	8.5	10.5	70	2.3	37	42.5	21	7	282	251	249	255	275
AW60(K)	70	66	66	11	13	90	3.2	—	—	—	—	448	417	416	422	442

Note) The total length of B dimension is the length when the filter regulator knob is unlocked.

# Filter Regulator AW20 to AW60 Made to Order

Please contact SMC for detailed dimensions, specifications, and lead times.



## ① Special Temperature Environment

Special materials are used in the manufacturing of seals and resin parts to allow them to withstand various temperature conditions in cold or tropical (hot) climates.

### Specifications

Made-to-order part no.	-X430	-X440
Environment	Low temperature	High temperature
Ambient temperature (°C)	-30 to 60°C	-5 to 80°C
Fluid temperature (°C)	-5 to 60°C (with no freezing)	
Material	Rubber parts	FKM
	Main parts	Metal (Aluminum die-cast), etc.

### Applicable Model

Model	AW30	AW40	AW40-06	AW60
Port size	1/4, 3/8	1/4, 3/8, 1/2	3/4	3/4, 1

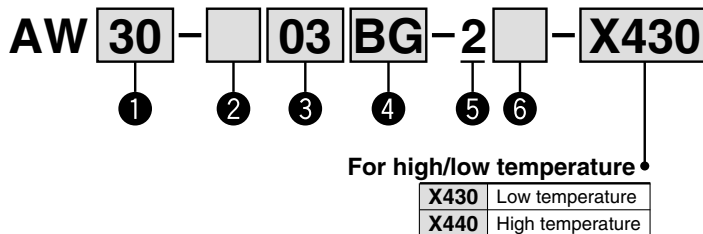

- Option/Semi-standard: Select one each for a to g.
- Option/Semi-standard symbol: When more than one specification is required, indicate in ascending alphanumeric order.  
Example) AW30-03BG-2N-X430

	Symbol	Description	① Body size		
			30	40	60
② Thread type	—	Rc	●	●	●
	N	NPT	●	●	●
	F	G	●	●	●
③ Port size	+ 02	1/4	●	●	—
	03	3/8	●	●	—
	04	1/2	—	●	—
	06	3/4	—	●	●
	10	1	—	—	●
④ Option	a	Without mounting option	●	●	●
	B	With bracket	●	●	●
	H	With set nut (for panel fitting)	●	●	—
b	—	Without pressure gauge	●	●	●
	G	Round type pressure gauge (without limit indicator)	●	●	●
⑤ Bowl	2	Metal bowl	●	●	●
⑥ Semi-standard	c	0.05 to 0.85 MPa setting	●	●	●
	1	0.02 to 0.2 MPa setting	●	●	●
	d	With drain cock	●	●	●
	J	Drain guide 1/4	●	●	●
	e	Relieving type	●	●	●
	N	Non-relieving type	●	●	●
	f	Flow direction: Left to right	●	●	●
R	Flow direction: Right to left	●	●	●	
g	—	Name plate, caution plate for bowl, and pressure gauge in imperial units: MPa	●	●	●
	Z	Name plate, caution plate for bowl, and pressure gauge in imperial units: psi, °F	○ Note 8)	○ Note 8)	○ Note 8)

Note 1) Option B, G, H are not assembled and supplied loose at the time of shipment.

Note 2) Assembly includes a bracket and set nuts (AW30 to AW40)

Includes 2 mounting screws for the AW60

Note 3) Mounting thread for pressure gauge: 1/8 for the AW30, 1/4 for the AW40 and AW60. Pressure gauge type: G43

Note 4) Only metal bowl 2 is available.

Note 5) The only difference from the standard specifications is the adjusting spring for the regulator. It does not restrict the setting of 0.2 MPa or more. When the pressure gauge is attached, a 0.2 MPa pressure gauge will be fitted.

Note 6) Without a valve function

Note 7) For thread type: NPT. This product is for overseas use only according to the new Measurement Law. (The SI unit type is provided for use in Japan.)

Note 8) ○: For thread type: NPT only

## ② High Pressure

Strong materials are used in the manufacturing of air filters intended for high pressure operation. Also, construction modification allows a wider regulating pressure range.

### Specifications

Made-to-order part no.	<b>-X425</b>
Proof pressure (MPa)	3.0
Maximum operating pressure (MPa)	2.0
Set pressure range (MPa)	0.1 to 1.6
Ambient and fluid temperature (°C)	-5 to 60°C (with no freezing)



AW30-03-2-X425

### Applicable Model

Model	<b>AW20</b>	<b>AW30</b>	<b>AW40</b>	<b>AW40-06</b>	<b>AW60</b>
Port size	1/8, 1/4	1/4, 3/8	1/4, 3/8, 1/2	3/4	3/4, 1

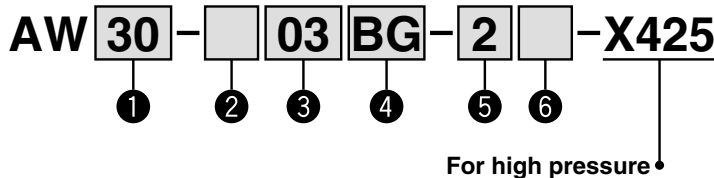

- Option/Semi-standard: Select one each for **a** to **f**.
- Option/Semi-standard symbol: When more than one specification is required, indicate in ascending alphanumeric order.  
Example) AW30-03BG-2N-X425

		Symbol	Description	① Body size				
				20	30	40	60	
②	Thread type	—	Rc	●	●	●	●	
		N	NPT	●	●	●	●	
		F	G	●	●	●	●	
+								
③	Port size	01	1/8	●	—	—	—	
		02	1/4	●	●	—	—	
		03	3/8	—	●	●	—	
		04	1/2	—	—	●	—	
		06	3/4	—	—	●	●	
		10	1	—	—	—	●	
+								
④	Option a Mounting	—	Without mounting option	●	●	●	●	
		B Note 2)	With bracket	●	●	●	●	
		H	With set nut (for panel fitting)	●	●	●	—	
+								
④	Option b Pressure gauge	—	Without pressure gauge	●	●	●	●	
		G Note 3)	Round type pressure gauge (with limit indicator)	●	●	●	●	
+								
⑤	Bowl Note 4)	2	Metal bowl	●	●	●	●	
		8	Metal bowl with level gauge	—	●	●	●	
+								
⑥	Semi-standard c Exhaust mechanism	—	Relieving type	●	●	●	●	
		N	Non-relieving type	●	●	●	●	
	+							
	Semi-standard d Drain port	—	With drain cock	●	●	●	●	
		J Note 5)	Drain guide 1/8	●	—	—	—	
		J Note 5)	Drain guide 1/4	—	●	●	●	
	+							
	Semi-standard e Flow direction	—	Flow direction: Left to right	●	●	●	●	
R		Flow direction: Right to left	●	●	●	●		
+								
Semi-standard f Pressure unit	—	Name plate, caution plate for bowl, and pressure gauge in imperial units: MPa	●	●	●	●		
	Z Note 6)	Name plate, caution plate for bowl, and pressure gauge in imperial units: psi, °F	○ Note 7)	○ Note 7)	○ Note 7)	○ Note 7)		

Note 1) Option B, G, H are not assembled and supplied loose at the time of shipment.

Note 2) Assembly includes a bracket and set nuts (AW20 to AW40)

Includes 2 mounting screws for the AW60

Note 3) Mounting thread for pressure gauge: 1/8 for the AW20 and AW30, 1/4 for the AW40 and AW60. Pressure gauge type: G46-20-□

Note 4) Only metal bowl 2 and 8 are available.

Note 5) Without a valve function

Note 6) For thread type: NPT. This product is for overseas use only according to the new Measurement Law. (The SI unit type is provided for use in Japan.)

Note 7) ○: For thread type: NPT only

# Filter Regulator *AW10 to AW60* Filter Regulator with Backflow Function *AW20K to AW60K* Made to Order



Please contact SMC for detailed dimensions, specifications, and lead times.

## ③ 0.4 MPa Setting

The maximum set pressure is 0.4 MPa. When a pressure gauge is included, the display will show a range from 0 to 0.4 MPa.

### Specifications

Proof pressure	1.5 MPa
Maximum operating pressure	1.0 MPa
Set pressure range	0.05 to 0.4 MPa

### Applicable Model

Model	AW10	AW20(K)	AW30(K)	AW40(K)	AW40(K)-06	AW60(K)
Port size	M5	1/8, 1/4	1/4, 3/8	1/4, 3/8, 1/2	3/4	3/4, 1

## ④ Long Bowl

Drain capacity is greater than that of standard models.

### Applicable Model/Drain Capacity

Model	AW10	AW20(K)	AW30(K)	AW40(K)	AW40(K)-06	AW60(K)
Port size	M5	1/8, 1/4	1/4, 3/8	1/4, 3/8, 1/2	3/4	3/4, 1
Drain capacity (cm <sup>3</sup> )	9	19	43	88		

Note) Please consult SMC for dimensions.

## How to Order

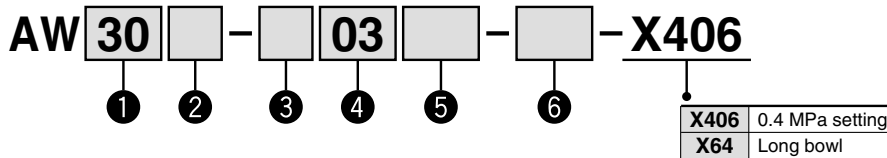

- Option/Semi-standard: Select one each for a to i.
  - Option/Semi-standard symbol: When more than one specification is required, indicate in ascending alphanumeric order.
- Example) AW30K-03BE-2N-X406

## 0.4 MPa Setting      Long Bowl

	Symbol	Description	① Body size					① Body size					
			10	20	30	40	60	10	20	30	40	60	
② With backflow function	—	Without backflow function	●	●	●	●	●	●	●	●	●	●	
	K Note 1	With backflow function	—	●	●	●	●	—	●	●	●	●	
③ Thread type	—	Metric thread (M5)	●	—	—	—	—	●	—	—	—	—	
	Rc	Rc	—	●	●	●	●	—	●	●	●	●	
	N Note 2	NPT	—	●	●	●	●	—	●	●	●	●	
	F Note 3	G	—	●	●	●	●	—	●	●	●	●	
④ Port size	M5	M5	●	—	—	—	—	●	—	—	—	—	
	01	1/8	—	●	—	—	—	—	●	—	—	—	
	02	1/4	—	—	●	—	—	—	—	●	—	—	
	03	3/8	—	—	●	—	—	—	—	●	—	—	
	04	1/2	—	—	—	●	—	—	—	—	●	—	
	06	3/4	—	—	—	●	●	—	—	—	●	●	
⑤ Option	a Mounting	—	Without mounting option	●	●	●	●	●	●	●	●	●	●
		B Note 5	With bracket	●	●	●	●	●	●	●	●	●	●
		H	With set nut (for panel fitting)	●	●	●	●	—	●	●	●	●	—
	b Float type auto drain	—	Without auto drain	●	●	●	●	●	—	—	—	—	—
		C	Float type auto drain (N.C.)	●	●	●	●	●	—	—	—	—	—
		D	Float type auto drain (N.O.)	—	—	●	●	●	—	—	—	—	—
	c Pressure gauge	—	Without pressure gauge	●	●	●	●	●	●	●	●	●	●
		E	Square embedded type pressure gauge (with limit indicator)	—	●	●	●	●	—	●	●	●	●
		G	Round type pressure gauge (without limit indicator)	●	—	—	—	—	●	—	—	—	—
		M	Round type pressure gauge (with limit indicator)	—	●	●	●	●	—	●	●	●	●
		M	Round type pressure gauge (with colour zone)	—	●	●	●	●	—	●	●	●	●
		Digital pressure switch	E1 Note 6	Output: NPN output / Electrical entry: Wiring bottom entry	—	●	●	●	●	—	●	●	●
E2 Note 6	Output: NPN output / Electrical entry: Wiring top entry		—	●	●	●	●	—	●	●	●	●	
E3 Note 6	Output: PNP output / Electrical entry: Wiring bottom entry		—	●	●	●	●	—	●	●	●	●	
E4 Note 6	Output: PNP output / Electrical entry: Wiring top entry		—	●	●	●	●	—	●	●	●	●	

Note 1) The AW10 type comes with a backflow function as a standard feature. (K is not available.) When using the AW10 type as w/ backflow function, backflow may not occur with the set pressure 0.15 MPa or less. Please set the inlet pressure to at least 0.05 MPa higher than the set pressure.

Note 2) Drain guide is NPT1/8 (applicable to the AW20(K)) and NPT1/4 (applicable to the AW30(K) to AW60(K)). The auto drain port comes with a ø3/8" one-touch fitting (applicable to the AW30(K) to AW60(K)).

Note 3) Drain guide is G1/8 (applicable to the AW20(K)) and G1/4 (applicable to the AW30(K) to AW60(K)).

Note 4) Option B, G, H and M are not assembled and supplied loose at the time of shipment.

Note 5) Assembly of a bracket and set nuts. (AW10, AW20(K) to AW40(K)). Includes 2 mounting screws for the AW60(K)

Note 6) When choosing with H (panel mount), the installation space for lead wires will not be secured. In this case, select "wiring down entry" for the electrical entry.

			0.4 MPa Setting					Long Bowl											
			①					①											
			Body size					Body size											
			10	20	30	40	60	10	20	30	40	60							
6	d	Set pressure	—	Note 7)		0.05 to 0.85 MPa setting					●	●	●	●	●				
			1	Note 8)		0.02 to 0.2 MPa setting					●	●	●	●	●				
				+															
	e	Bowl		—	Polycarbonate bowl										●	●	●	●	●
				2	Metal bowl										●	●	●	●	●
				6	Nylon bowl										●	●	●	●	●
				8	Metal bowl with level gauge										—	—	—	—	—
				C	With bowl guard										—	●	—	—	—
				+															
	f	Note 9) Drain port		—	With drain cock										●	●	●	●	●
				J	Note 10)		Drain guide 1/8					—	●	—	—	—			
				W	Note 11)		Drain guide 1/4					—	—	●	●	●			
				+															
	g	Exhaust mechanism		—	Relieving type										●	●	●	●	●
				N	Non-relieving type										●	●	●	●	●
			+																
h	Flow direction		—	Flow direction: Left to right										●	●	●	●	●	
			R	Flow direction: Right to left										●	●	●	●	●	
			+																
i	Pressure unit		—	Name plate, caution plate for bowl, and pressure gauge in imperial units: MPa										●	●	●	●	●	
			Z	Note 12)		Name plate, caution plate for bowl, and pressure gauge in imperial units: psi, °F					○	○	○	○	○				
			ZA	Note 13)		Digital pressure switch: With unit conversion function					—	△	△	△	△				

Note 7) Only the AW10 has a pressure setting of 0.05 to 0.7 MPa.

Note 8) The only difference from the standard specifications is the adjusting spring for the regulator. It does not restrict the setting of 0.2 MPa or more. When the pressure gauge is attached, a 0.2 MPa pressure gauge will be fitted.

Note 9) Float type auto drain: The combination between C or D is not available with the drain port option.

Note 10) Without a valve function

Note 11) Metal bowl: The combination of 2 and 8 cannot be selected with W.

Note 12) For thread type: M5 and NPT. This product is for overseas use only according to the new Measurement Law. (The SI unit type is provided for use in Japan.)  
The digital pressure switch will be equipped with the unit conversion function, setting to psi initially.

Note 13) For options: E1, E2, E3, E4. This product is for overseas use only according to the new Measurement Law. (The SI unit is provided for use in Japan.)

Note 14) ○: For thread type: M5 and NPT only

Note 15) △: Select with options: E1, E2, E3, E4.