

Slim I/O Relay
Slim I/O Solid State Relay
G2RV-ST/G3RV-ST

OMRON

Space Saving and Easy Installation for your Control Panel



For building green control panels

Natural disasters caused by global warming and climate change are becoming a global social issue, that drives over 150 countries and regions worldwide to take action toward decarbonization. Our goal is to reduce greenhouse gas (GHG) emissions toward half by through new ways of building control panels, that key figure of the manufacturing site.



Process

Realize greatly reduces design/ manufacturing work

Innovation for design, building Process

Further Evolution for Panels

Panel

Realize compact & highly reliable control panels

Building sustainable control panels

Creating green control panels

Simple & Easy People

Green

Reducing GHG emission of control panels to achieve carbon neutrality

People

Provide reliable and comfortable manufacturing for all people who deal with control panels



Integrating green perspectives into Value Design

Value Design for Panel (Value Design) is the common concept shared across OMRON's in-panel product specifications to deliver new value to your control panels.

This Value Design also integrate environment consideration concept that enable earth and user-friendly control panel building.



- 1 Unified height & slim size*¹
- 2 Side-by-side mounting at (55°C) ambient temperature*²
- 3 Unique Push-In Plus technology*¹
- 4 Front-in and front-release wiring
- 5 eCAD library
- 6 Certification for CE, UL, and CSA
- 7 **Green features that save energy and resources*³**

CFP of control panel (total GHG emissions)*⁴

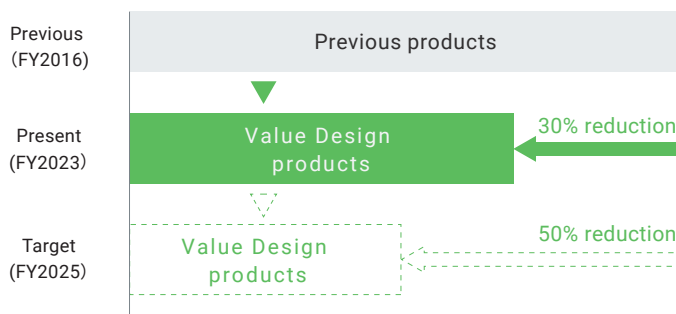

*1. Expect for some products

*2. Side-by-side mounting is possible in the same series

*3. Greener design compared to previous (2016) products

*4. CFP (carbon footprint) of control panel is a calculation result of referring the life cycle assessment method that based on international standards ISO14067 which define CO₂ quantitative conversion of the environmental burden at every stage, from manufacturing, transportation, use, and disposal of the control panel (product). According to OMRON investigation in May 2023.

Saving Space and More-advanced Control Panels

The interface wiring system of the smallest size industry*1 help delivering more compact control panels with additional functionality.



Replace existing relays with 6.2 mm-wide relays to use space effectively

By replacing existing relays, you can downsize your control panel and enhance your equipment while maintaining its size.

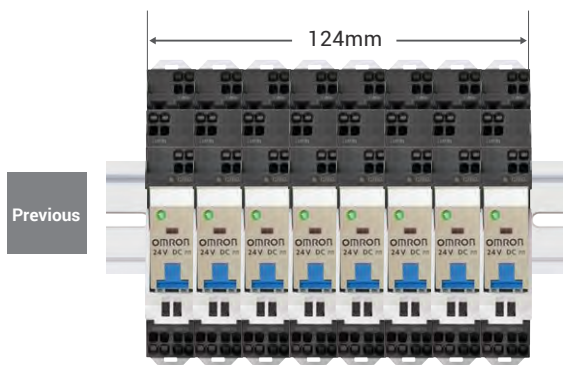

Smallest in industry*1
6.2 mm

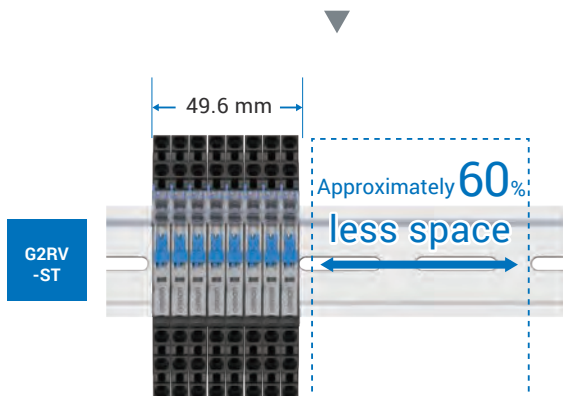
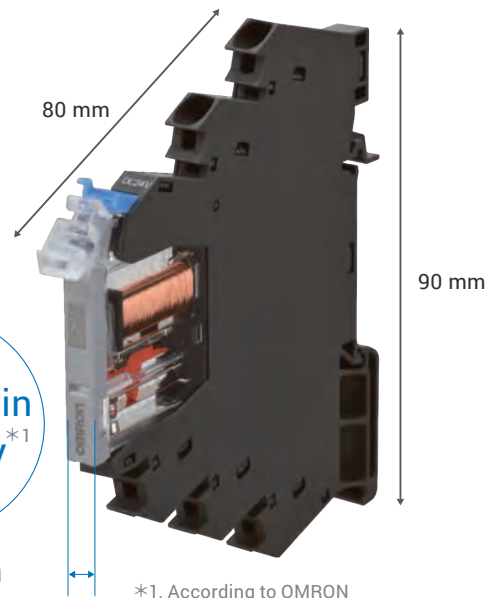

The saved space can be used for implementing additional functions such as safety or IoT.

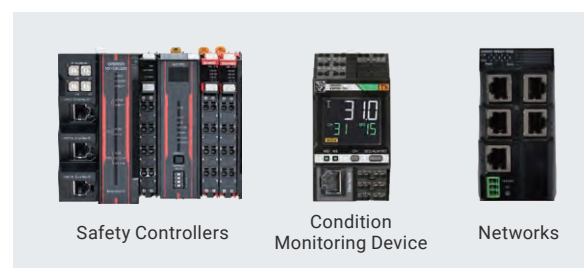

Unified height reduces dead space and downsizes control panels

Our Value Design for Panel relays and their sockets are of the same height.

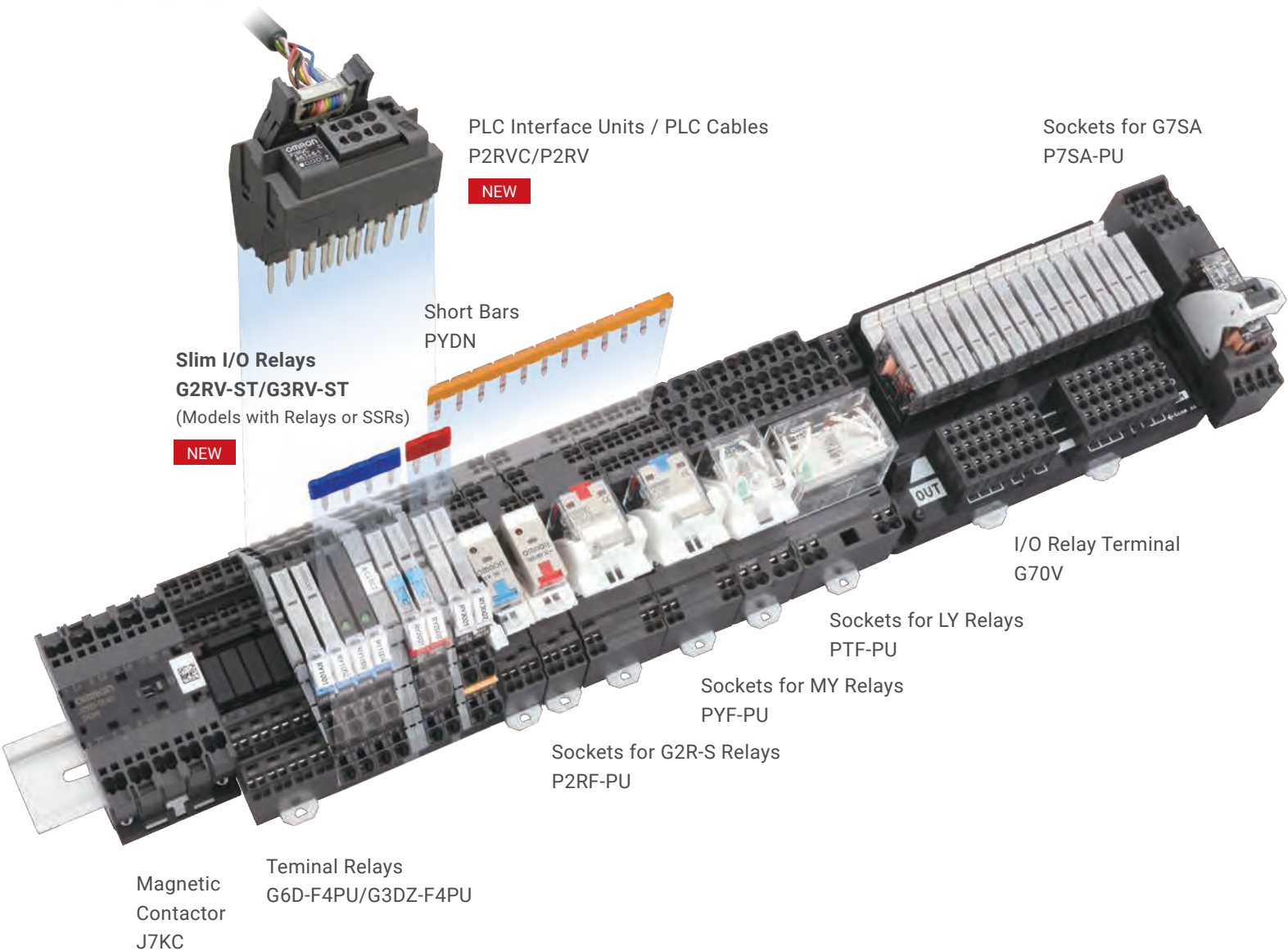
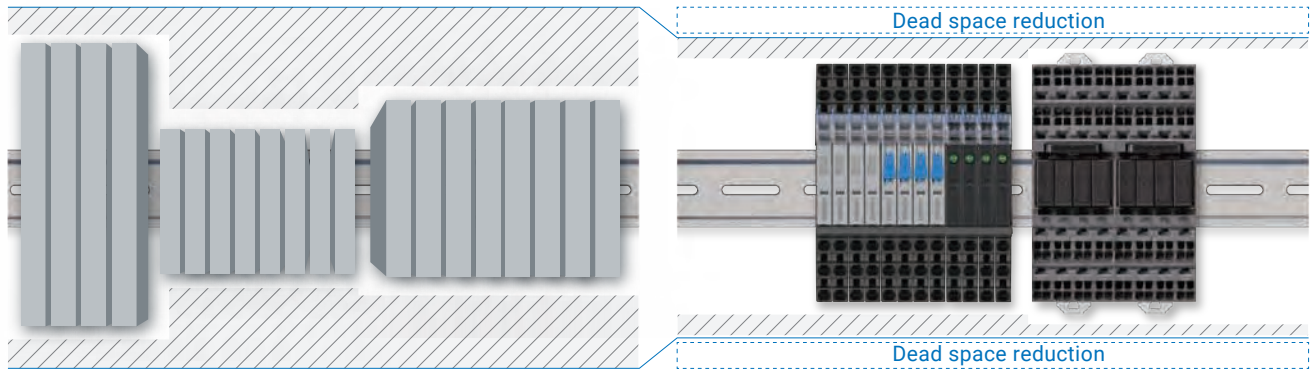

Shortening Lead Time for Control Panel Building

Unique product specifications let you shorten the entire process for building control panels.

Issues on control panels process

Our response is required to meet customer needs by increasing process speed...

Design → Assembly/Wiring → Shipment/Operation

Design → Assembly/Wiring → Shipment/Operation

Push-In Plus technology requires only a single step, greatly reducing wiring work

Reduction of approx. 60%*1

1. Remove the screw
2. Connect with the terminal
3. Tighten the screw
4. Put a check mark
5. Retighten the screw

1. Insert the terminal

Previous A lot of steps are required to complete wiring for the screw terminal...

Value Design for Panel Push-In Plus technology completes by a single step

*1. Information for Push-In Plus and Screw Terminal Blocks is based on OMRON's actual measurement data

Larger wire terminal opening contributes to efficiency of wiring and standardization of wires

Wiring holes are wide in diameter and are structured diagonally to allow for better visibility and easy insertion, and support standard 2.5 mm² ferrule terminals.



2.5 mm² ferrule available

2.0 mm² standardization on DC line on request basis

PLC interface unit and short bars further reduce wiring effort

Our extensive lineup of accessories for reducing wiring allows for less wiring work and therefore less effort.

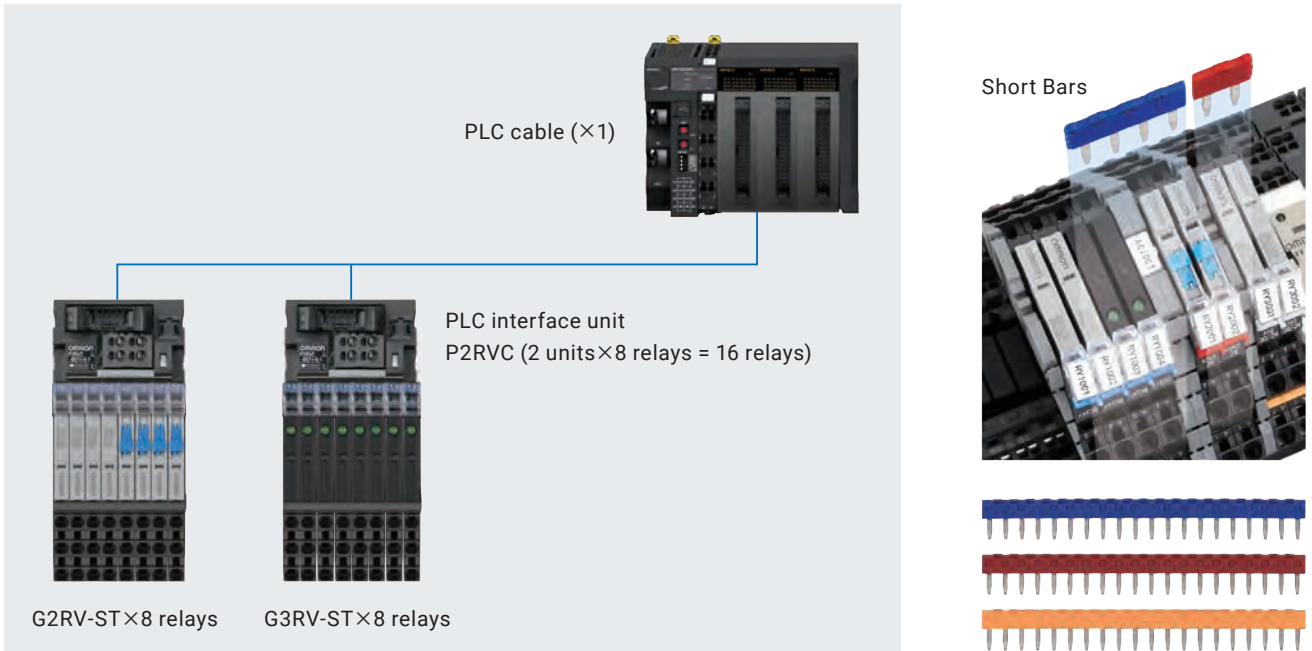

No need for retightening, even when vibration is applied on terminals

The pressure of the clamp spring holds the ferrule or wire securely with Push-In Plus technology, eliminating worries about screws loosening or disconnection due to vibration.

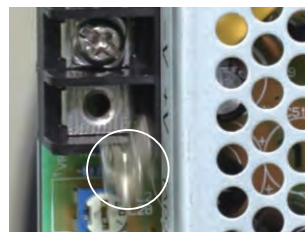

Previous

The screw is loosened and dropped by vibration...

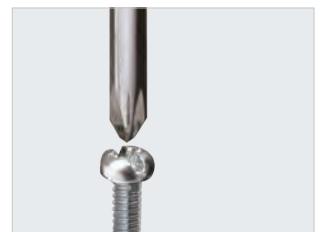

Retightening is needed before export and shipment...



Value Design
for
Panel

No drop-off or retightening of screws

Reducing the burden of building, operating, and maintaining control panels

Made to be less taxing on the health of those who build control panels and more useful to on-site users.

Issues on control panels wiring

Increasing devices in accordance with more advanced control panels require much time for wiring with screw terminals...

Screw terminals, which require wiring in vertical direction, will impose workers additional hassle for caring wiring order...

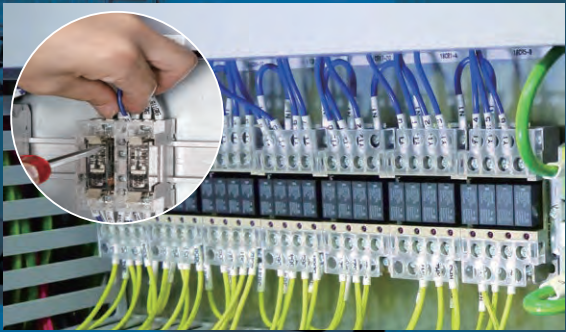
Installation friendly assembly/wiring with less burden on worker's health

Push-In Plus technology with reliability and ease of insertion

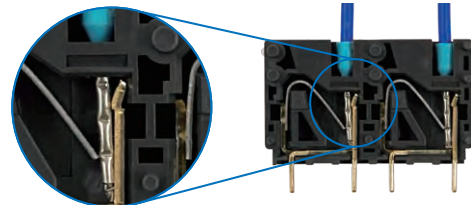
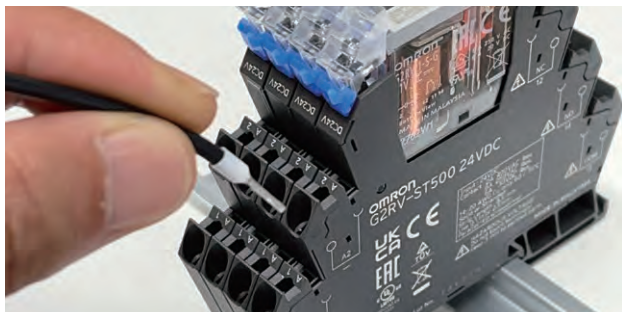

IEC standard *1 Push-In Plus *2 Screw *2

20 N min.	125 N	112 N
-----------	-------	-------

OMRON's Push-In Plus technology is as easy as inserting to an earphone jack. This reduces the load on workers fingers.

Even though less insertion force is required, the wires are held firmly in place by a unique spring structure that ensures reliability.

*1. In the case that a cable diameter is AWG20, 0.5 mm² *2. OMRON's actual measurement value data.

Easy-to-install accessories

Short bars and insulation plates can be cut or removed with little force to deliver stress-free workability.

Short Bars



Can be cut easily with average grip force.

Note. Target cutting force: 25 k

Isolation plate



Extra support is provided through an enhanced mounting system

Work efficiency is enhanced by DIN rail sliding performance and short bar improvements.

DIN rail tolerance is also supported through elasticity



Extra support is provided through an enhanced mounting system.

Short Bars



Insertion feedback to let you know when mounting is complete.

Easier Maintenance

Visibility is enhanced by the LED release lever

Visibility from the front is improved by a structure where the actual release lever lights and by expanding the light emission area.



Note. The third relay from the right is equipped with a label.

Color coded stoppers indicate the voltage type

Voltage systems are color-coded for easy checking.

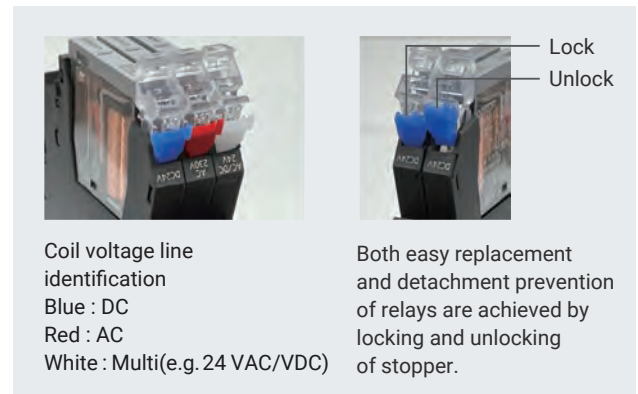

Use insulation plates to prevent electrical shock and separation of groups easier

You can attach insulation plates to the ends of short bars to prevent electrical shock and separation.



Electrical shock hazard



Insulation plate prevent electrical shock

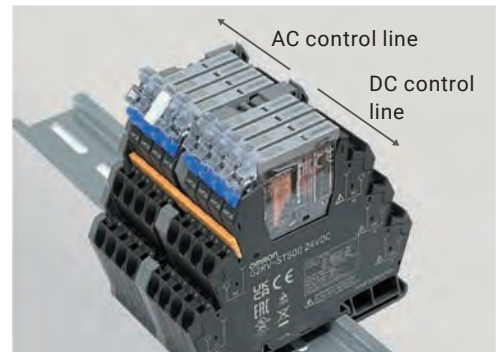

Separation groups

Relay structure allows for easy checking and replacement

The relays themselves are designed to the finest detail for ease of use, allowing for easy operation checks and replacement.

Easy operation checks

- Transparent case for checking relay state
- Test buttons for checking circuit
- Mechanical indicator for checking operation



Easy replacement

- Easy relay replacement by hard to bend terminal structure



Reducing greenhouse gas emissions

Our Value Design products reduce greenhouse gas emissions by making control panels smaller and lighter, and their devices more power efficient.

Value Design products reduce emissions by 15% or more.

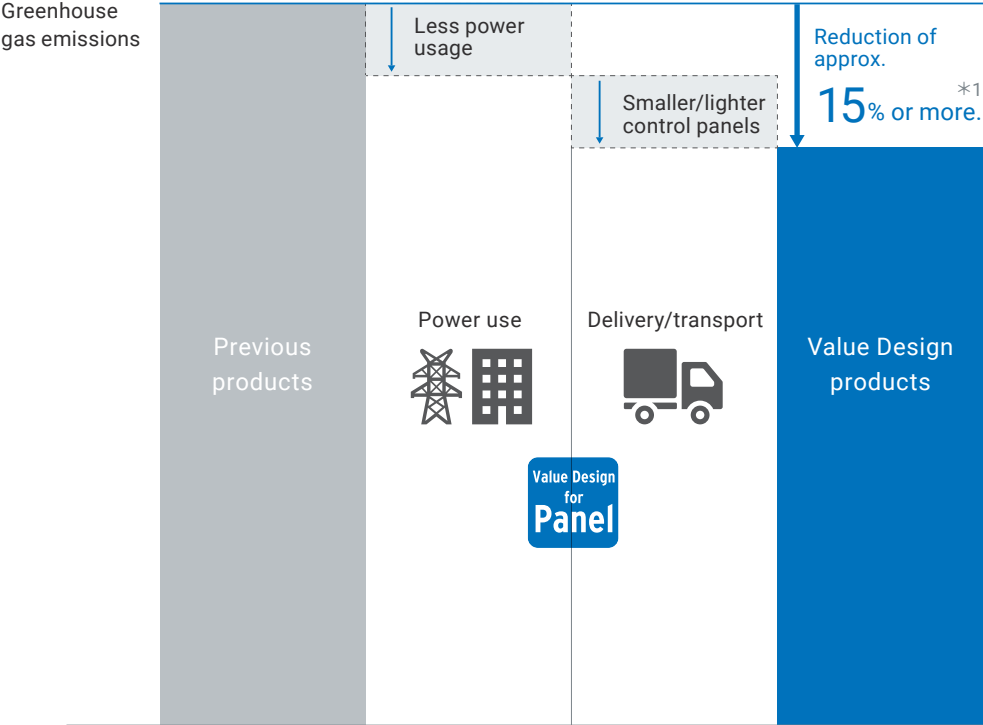

*1. Estimates as of February 2022, using OMRON's model control panel

Product lineup

G2RV-ST (Slim I/O Relay)

Terminal(Wire connection)	Classification	Latching lever (Test switch)	Rated input voltage (V)	Model	Dimensions W×H×D (mm)
Push-In Plus Terminal	Standard	No	24 VDC	G2RV-ST500 24 VDC	6.2 x 90 x 88
			24 VAC/VDC	G2RV-ST500 24 VAC/VDC	
			200 VAC	G2RV-ST500 200 VAC	
	Microloads	なし	24 VDC	G2RV-ST500-AP 24 VDC	
			24 VAC/VDC	G2RV-ST500-AP 24 VAC/VDC	
Screw terminal	Standard	No	24 VDC	G2RV-ST700 24 VDC	
		Yes	24 VDC	G2RV-ST701 24 VDC	
	Microloads	No	24 VDC	G2RV-ST700-AP 24 VDC	

Note. The above products are excerpts.Refer to the G2RV-ST/G3RV-ST Slim I/O Relay/Slim I/O Solid State Relay Datasheet (Cat. No. J214) for details.

G3RV-ST (Slim I/O Solid State Relay)

Terminal(Wire connection)	Applicable output load	Zero cross function	Rated input voltage (V)	Model	Dimensions
Push-In Plus Terminal	DC load	-	24 VDC	G3RV-ST500-D 24 VDC	6.2 x 90 x 88
			24 VAC/VDC	G3RV-ST500-D 24 VAC/VDC	
	DC load(high-speed opening and closing)		24 VDC	G3RV-ST500-D-H 24 VDC	
			24 VAC/VDC	G3RV-ST500-D-H 24 VAC/VDC	
	AC load	Yes	12 VDC	G3RV-ST500-A 12 VDC	
			24 VDC	G3RV-ST500-A 24 VDC	
Screw terminal	DC load	-	24 VDC	G3RV-ST700-D 24 VDC	
			DC load(high-speed opening and closing)	-	24 VDC
	AC load	Yes			12 VDC
		No	24 VDC	G3RV-ST700-AL 24 VDC	

Note. The above products are excerpts.Refer to the G2RV-ST/G3RV-ST Slim I/O Relay/Slim I/O Solid State Relay Datasheet (Cat. No. J214) for details.

For G2RV-ST/G3RV-ST Common Accessories

Short Bars

Pitch	No. of poles	Colors	Model *	Minimum order(Quantity)	Maximum energizing current
6.2mm	20	Red (R), Blue (S), Yellow (Y)	PYDN-6.2ST-200□	10	32A

Note. Use for wiring to the adjacent socket.

* Replace the box (□) in the model number with the code for the covering color. □ color selection: R = red, S = blue, Y = yellow

Isolation plate

Model
P2RV-P3.1ST

Isolation plate

I/O classification	Connection method	Common process	Applicable Models *	Model
For input	Push-In	PNP	G2RV-ST500-AP	P2RVC-8ST-I-5-1
		NPN		P2RVC-8ST-I-5
	Screw	PNP	G2RV-ST700-AP	P2RVC-8ST-I-7-1
For output	Push-In	PNP	G2RV-ST500, G2RV-ST501, G3RV-ST500	P2RVC-8ST-O-5-1
		NPN		P2RVC-8ST-O-5
	Screw	PNP	G2RV-ST700, G2RV-ST701, G3RV-ST700	P2RVC-8ST-O-7-1

* Please make sure applicable models, P2RVC can not be used other combination than the above table.



Creating green control panels

Cat. No. Y235-E1

Natural disasters caused by global warming and climate change are a global social issue, driving over 150 countries and regions worldwide to take action toward decarbonization. Our goal is to cut greenhouse gas (GHG) emissions by half through new ways of building control panels, which constitute the core of the manufacturing site.

Other company names and product names in this document are the trademarks or registered trademarks of their respective companies
Microsoft product screen shot(s) reprinted with permission from Microsoft Corporation.
The permission of Shutterstock.com was received for images that were used.

Note: Do not use this document to operate the Unit.

OMRON Corporation Industrial Automation Company

Kyoto, JAPAN

Contact : www.ia.omron.com

Regional Headquarters

OMRON EUROPE B.V.

Wegalaan 67-69, 2132 JD Hoofddorp
The Netherlands
Tel: (31) 2356-81-300 Fax: (31) 2356-81-388

OMRON ELECTRONICS LLC

2895 Greenspoint Parkway, Suite 200
Hoffman Estates, IL 60169 U.S.A.
Tel: (1) 847-843-7900 Fax: (1) 847-843-7787

OMRON ASIA PACIFIC PTE. LTD.

438B Alexandra Road, #08-01/02 Alexandra
Technopark, Singapore 119968
Tel: (65) 6835-3011 Fax: (65) 6835-2711

OMRON (CHINA) CO., LTD.

Room 2211, Bank of China Tower,
200 Yin Cheng Zhong Road,
PuDong New Area, Shanghai, 200120, China
Tel: (86) 21-5037-2222 Fax: (86) 21-5037-2200

Authorized Distributor:

©OMRON Corporation 2022-2023 All Rights Reserved.
In the interest of product improvement,
specifications are subject to change without notice.

CSM_3_1

Cat. No. J266-E1-04 1023 (0922)