

Электропневматический преобразователь высокого давления

ITVX2000

G3/8

Предназначен для преобразования электрического управляющего сигнала в пропорциональное по величине давление на выходе

- Входное давление до 5 МПа, диапазон регулирования 0.01 ~ 3.0 МПа
- Используется для обдува, в частности, при лазерной резке
- Возможность выбора устройства с электрическим аналоговым или дискретным входом / выходом
- Индикация выходного давления

Пример применения

Станок для лазерной резки

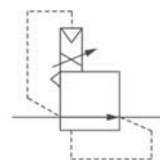
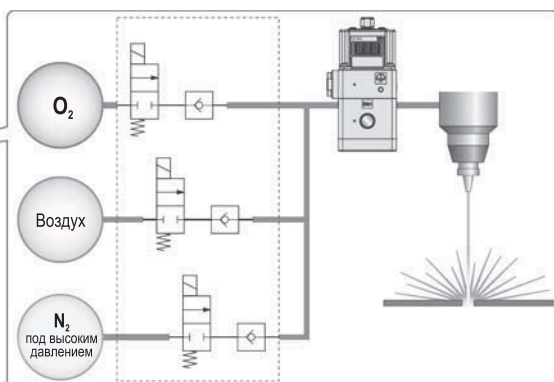

Технические характеристики

Минимальное рабочее давление (МПа)		Давление на выходе + 0.2 (но не менее 0.5 МПа)
Максимальное рабочее давление (МПа)		5.0
Диапазон регулирования (МПа)		0.01 ~ 3.0
Максимальный расход (норм.л/мин.)		3000 (рабочее давление 5 МПа, давление на выходе 3 МПа)
Рабочая среда		Сжатый воздух, азот, кислород ¹⁾ , аргон
Присоединительная резьба		G3/8
Электропитание	Напряжение	24 V DC ±10%
	Потребление тока (А)	Не более 0.12
Входной сигнал	Аналоговое управление по току ²⁾	4 ~ 20 mA, 0 ~ 20 mA
	Аналоговое управление по напряжению	0 ~ 5 VDC, 0 ~ 10 VDC
Входное сопротивление	Аналоговое управление по току	Не более 500 Ом
	Аналоговое управление по напряжению	6 ~ 6.5 кОм
Выходной сигнал (для контроля) ³⁾	Аналоговый выход	1 ~ 5 V DC (выходное сопротивление около 1 кОм, точность ≤ ±6% от полного диапазона)
		4 ~ 20 mA (сопротивление нагрузки не более 250 Ом, точность ≤ ±6% от полного диапазона)
	Дискретный выход	NPN открытый коллектор: макс. 30 В, 80 mA, гистерезис ± 3% от полного диапазона, самодиагностика ≤ ± 5% от полного диапазона
		PNP открытый коллектор: макс. 80 mA, гистерезис ± 3% от полного диапазона, самодиагностика ≤ ± 5% от полного диапазона
Линейность		≤ ±1% (от полного диапазона регулирования)
Гистерезис		≤ 1% (от полного диапазона регулирования)
Воспроизводимость		≤ ±1% (от полного диапазона регулирования)
Чувствительность		≤ ±1% (от полного диапазона регулирования)
Влияние температуры		≤ ±0.12% (от полного диапазона регулирования)/°C
Индикация выходного давления	Точность	±2% (% от полного диапазона регулирования) ± 1 единица младшего разряда
	Минимальное значение	0.01 МПа
Температура рабочей и окружающей среды (°C)		0 ~ 50 (не допускать образования конденсата)
Вес (г)		570

1) Для кислорода максимальное рабочее давление составляет 1.0 МПа

2) 2-х проводной вариант 4~20 mA не выпускается. Требуется электропитание 24 или 12~15 V DC.

3) Можно выбрать либо аналоговый, либо дискретный выход.

При дискретном варианте требуется выбрать между NPN и PNP выходом. Для выхода 1 ~ 5 VDC, если сопротивление нагрузки превышает 100 кОм может быть не достигнута заявленная точность ±6% от полного диапазона регулирования

4) Устройство следует использовать только для обдува

Характеристики расхода

Давление на входе 1.0 МПа

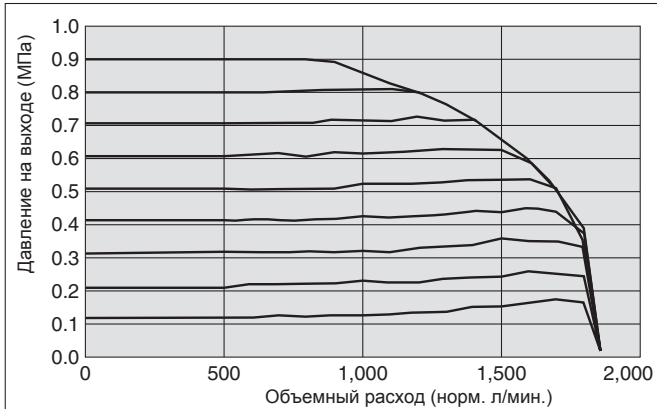

Номер для заказа

ITVX2030 - 0 1 F3N

Входной сигнал

0	Ток 4~20 мА
1	Ток 0~20 мА
2	Напряжение 0~5 V DC
3	Напряжение 0~10 V DC

Выходной сигнал

1	Аналоговый 1~5 V DC
2	Дискретный NPN
3	Дискретный PNP
4	Аналоговый 4~20 мА

Принадлежности (заказываются отдельно)

Наименование	Номер для заказа	
Монтажная скоба*	КТ-ITV-F2	
Крепежный угольник*	КТ-ITV-L2	
Ответная часть разъема с кабелем 3 м	Прямой тип	Р398020-500-3
	Угловой тип	Р398020-501-3

*Установочные винты в комплекте

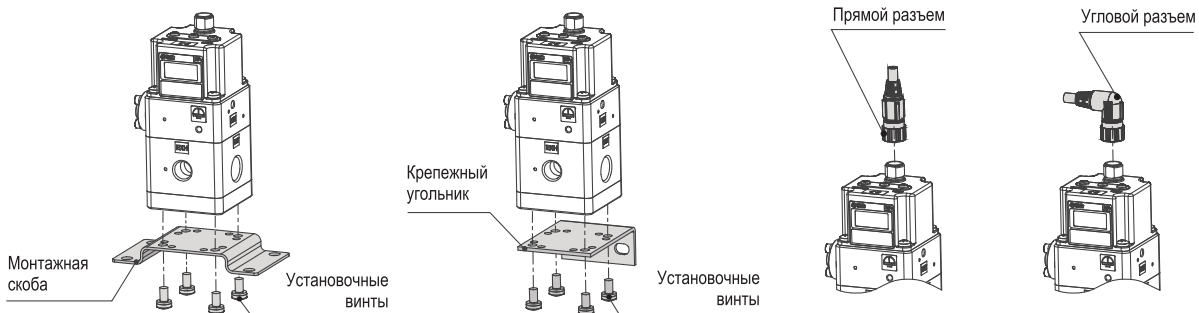

5.0 MPa Maximum Supply Pressure

New

High Pressure Electro-Pneumatic Regulator



⚠ Caution

This product is only for blowing gas. This product does not have sufficient pressure control for other applications (driving, sealing, etc.).

Stepless control of air pressure proportional to an electrical signal

Maximum supply pressure: **5.0 MPa**

Set pressure range: **0.01 to 3.0 MPa**

Maximum flow rate: **3000 L/min [ANR]***

*Supply pressure: 5.0 MPa Set pressure: 3.0 MPa

Fluid: **Air, N₂, O₂, Ar**

Wetted parts: Fluorine grease

Power consumption
3 W or less

Digital pressure display



Application example

Laser beam machine

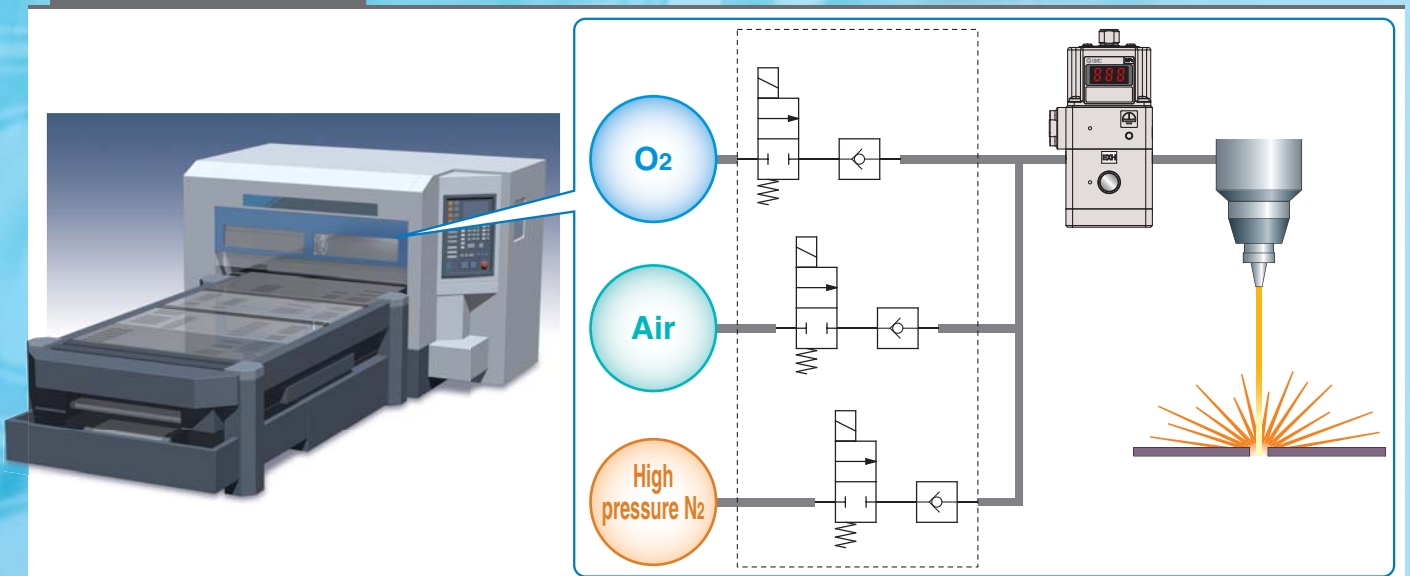

Series **ITVX**



CAT.ES60-21A

5.0 MPa Maximum Supply Pressure High Pressure Electro-Pneumatic Regulator



Series *ITVX2000*

How to Order

ITVX2030-01 3 S

Body size

2	ITVX2000
---	----------

Pilot style

0	Built-in regulator type <small>Note)</small>
---	--

Note) For details, refer to page 3 "Working Principle."

Set pressure range

3	0.01 to 3.0 MPa
---	-----------------

Power supply voltage

0	24 VDC
---	--------

Input signal

0	Current type 4 to 20 mA DC (Sink type)
1	Current type 0 to 20 mA DC (Sink type)
2	Voltage type 0 to 5 VDC
3	Voltage type 0 to 10 VDC

Monitor output

1	Analog output 1 to 5 VDC
2	Switch output/NPN output
3	Switch output/PNP output
4	Analog output 4 to 20 mA DC (Sink type)

Thread type

Nil	Rc
N	NPT
F	G <small>Note)</small>

Note) Complies with ISO1179-1 (2007).

Port size

3	3/8 <small>Note)</small>
---	--------------------------

Note) The exhaust port size is 1/4". The exhaust port size for the built-in regulator and the solenoid valve is M5.

Pressure display unit



Nil	MPa
2 <small>Note)</small>	kgf/cm ²
3	bar
4 <small>Note)</small>	psi

Note) Under Japan's new Measurement Act, this is only for overseas sales (SI units are to be used inside Japan).

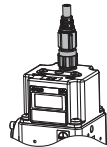
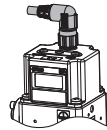
Cable connector type

S	Straight type 3 m 
L	Right angle type 3 m 
N	Without cable connector

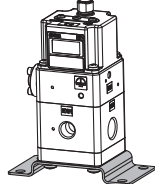
Bracket

Nil	Without bracket
B	Flat bracket 
C	L-bracket 

5.0 MPa Maximum Supply Pressure High Pressure Electro-Pneumatic Regulator *Series ITVX2000*

Standard Specifications



Symbol

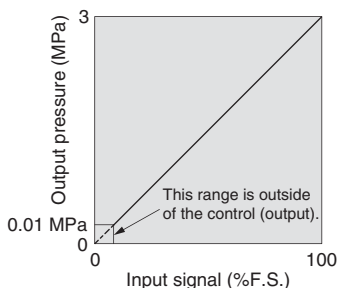
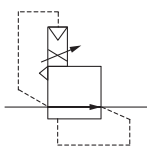

Fig. 2. Input/output characteristics chart

Model		ITVX2000
Minimum supply pressure		Whichever is higher: 0.5 MPa or the set pressure +0.2 MPa
Maximum supply pressure		5 MPa ^{Note 2)}
Set pressure range ^{Note 3)}		0.01 to 3.0 MPa
Power supply	Voltage	24 VDC $\pm 10\%$
	Current consumption	0.12 A or less
Input signal	Current type ^{Note 4)}	4 to 20 mA DC, 0 to 20 mA DC (Sink type)
	Voltage type	0 to 5 VDC, 0 to 10 VDC
Input impedance	Current type	500 Ω or less
	Voltage type	6 to 6.5 k Ω (at ordinary temperature)
Output signal (Monitor output) ^{Note 5)}	Analog output	1 to 5 VDC (Output impedance: Approx. 1 k Ω) Output accuracy: $\pm 6\%$ or less (Full span) 4 to 20 mA DC (Sink type) Load impedance: 250 Ω or less Output accuracy: $\pm 6\%$ or less (Full span)
	Switch output	NPN open collector output: Max. 30 V, 80 mA Hysteresis: $\pm 3\%$ (Full span), Self-diagnosis: $\pm 5\%$ or less (Full span) PNP open collector output: Max. 80 mA Hysteresis: $\pm 3\%$ (Full span), Self-diagnosis: $\pm 5\%$ or less (Full span)
Linearity		$\pm 1\%$ or less (Full span)
Hysteresis		1% or less (Full span)
Repeatability		$\pm 1\%$ or less (Full span)
Sensitivity		$\pm 1\%$ or less (Full span)
Temperature characteristics		$\pm 0.12\%$ or less (Full span)/ $^{\circ}\text{C}$
Output pressure display	Accuracy	$\pm 2\%$ or less (Full span) ± 1 digit
	Minimum unit ^{Note 6)}	MPa: 0.01, kgf/cm ² : 0.1, bar: 0.1, psi: 1
Fluid		Air, N ₂ , O ₂ , Ar
Ambient and fluid temperature		0 to 50 $^{\circ}\text{C}$ (No condensation)
Weight		Approx. 570 g (without options)

Note 1) Characteristics shown above are based on the piping conditions of Fig. 1.

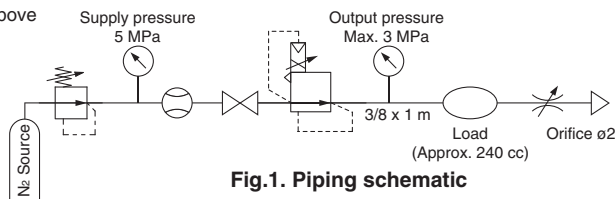

Fig. 1. Piping schematic

Note 2) When oxygen is used as a fluid, the maximum supply pressure must be less than 1 MPa.

Note 3) Refer to Fig. 2 for the relationship between set pressure and input signal.

Note 4) 2-wire type 4 to 20 mA DC is not available. Power supply voltage 24 VDC is required.

Note 5) Select either analog output or switch output. Further, when switch output is selected, select either NPN output or PNP output. When measuring analog output of 1 to 5 VDC with a load impedance less than 100 k Ω , the analog output may not obtain the output accuracy of $\pm 6\%$ or less (F.S.).

Note 6) Adjustment of numerical values such as the zero/span adjustment is set based on the minimum units for output pressure display. Note that the unit cannot be changed.

Note 7) This product is only for blowing gas. This product does not have sufficient pressure control for applications other than blowing (driving, sealing, etc.).

Note 8) This product is not certified by Japan's High Pressure Gas Safety Act.

Fluid Supply

⚠ Warning

1. Compressed air, nitrogen, oxygen or argon can be used as a fluid.
2. Do not use compressed air which includes chemicals, synthetic oils containing organic solvents, salt, or corrosive gases, etc., as this can cause damage or malfunction.
3. If oxygen is used as the fluid, it can lead to serious and unforeseen risks. However, it is possible to manage and control the risk of hazards and economic loss. In order to use the product safely, it should only be handled by personnel with appropriate knowledge, with support from a suitably qualified specialist.
4. Oxygen gas increases the susceptibility of substances to burning; Oxygen gas can be ignited by frictional heat and

static electricity. If oxygen is ignited, the metal and seal materials burn. Therefore, flush the piping thoroughly and mount a suitable filter to prevent foreign matter such as metal powder and dust from entering the product.

5. Take safety measures by installing safety devices (e.g. a circuit that stops the supply of oxygen gas) to prevent fire and explosion in the event of failure, taking flameproof safety standards into consideration.
6. Since there are three exhaust ports on the product, connect the piping in order to exhaust oxygen. Do not block the exhaust port.

Wiring

⚠ Caution

F.G. (Grounding)

Ground the frame ground (F.G.) terminal at the front of the main body. If the F.G. terminal port is not used, this product may not operate properly due to the noise.

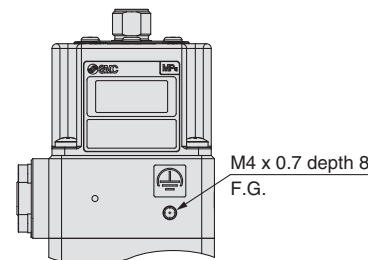

Series ITVX2000

Accessories (Option)/Part No.

Description	Part no.	
Flat bracket assembly (including mounting screws)	KT-ITV-F2	
L-bracket assembly (including mounting screws)	KT-ITV-L2	
Power cable connector	Straight type 3 m	P398020-500-3
	Right angle type 3 m	P398020-501-3

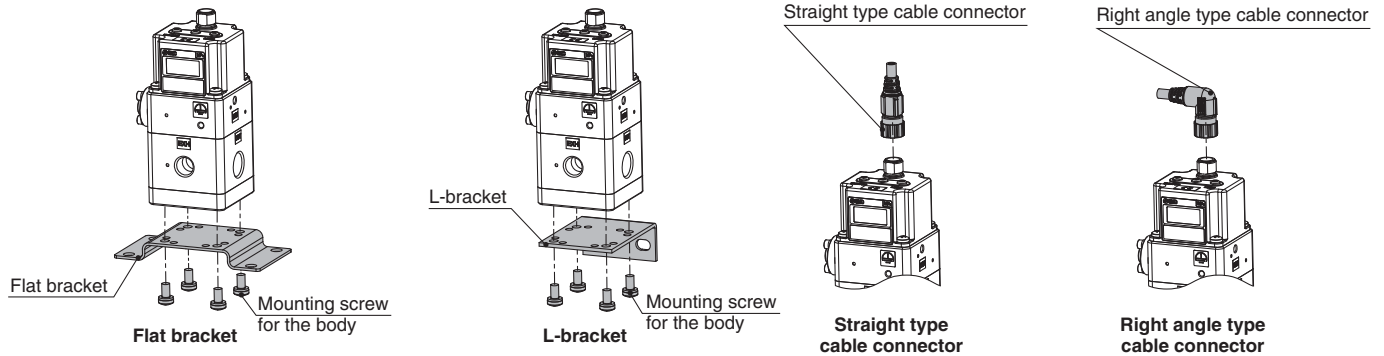

Dimensions

Flat bracket

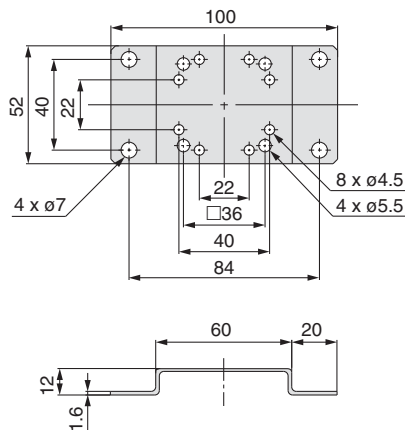

L-bracket

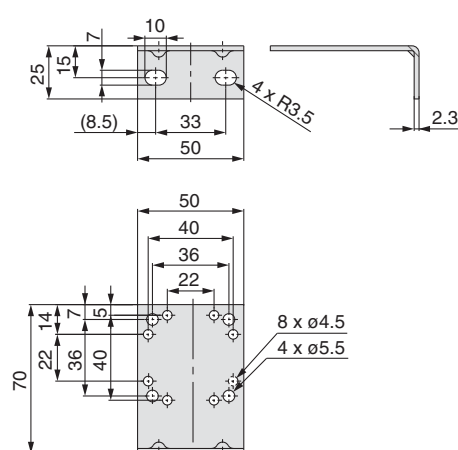

Working Principle

When the input signal rises, the **air supply solenoid valve** ① turns ON, and the **exhaust solenoid valve** ② turns OFF. Therefore, supply pressure regulated by a **built-in regulator** ③ passes through the **air supply solenoid valve** ① and is applied to the **pilot chamber** ④. The pressure in the **pilot chamber** ④ increases and operates on the upper surface of the **diaphragm** ⑤.

As a result, the **air supply valve** ⑥ linked to the **diaphragm** ⑤ opens, and a portion of the supply pressure becomes output pressure.

This output pressure feeds back to the **control circuit** ⑧ via the **pressure sensor** ⑦. Here, a correct operation functions until the output pressure is proportional to the input signal, making it possible to always obtain output pressure proportional to the input signal.

Working Principle Diagram

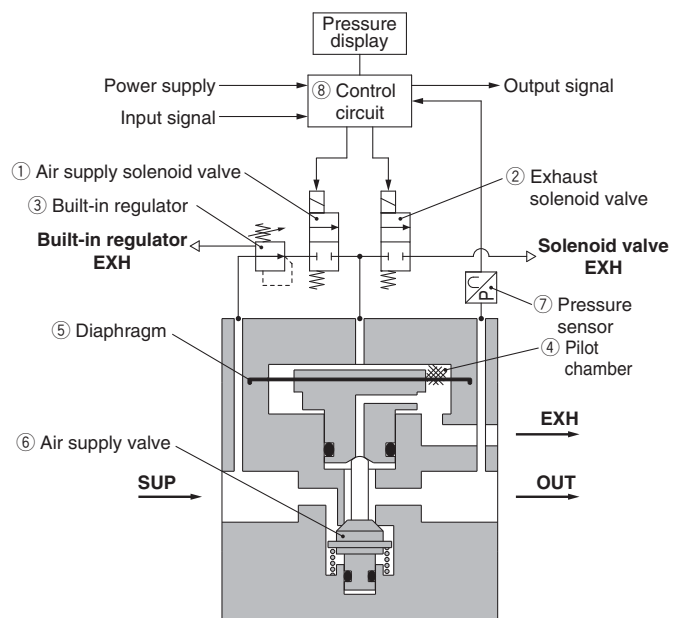

Series ITVX2000

Linearity

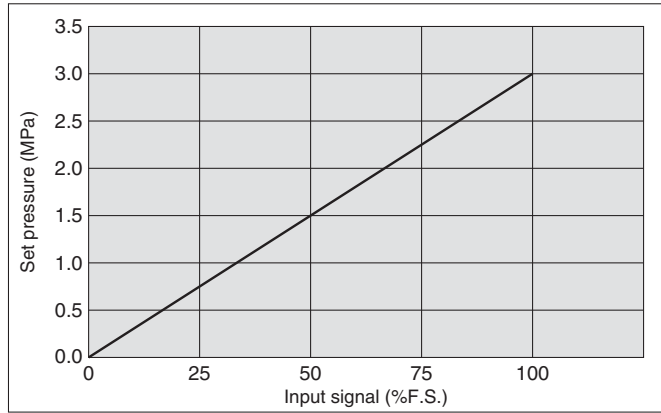

Hysteresis

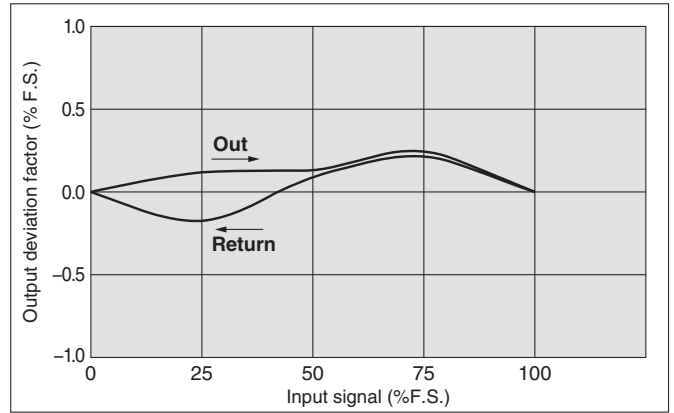

Repeatability

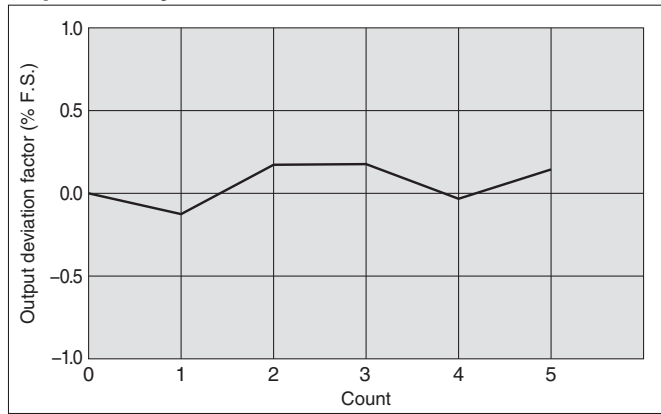

Pressure Characteristics

Set pressure: 0.4 MPa

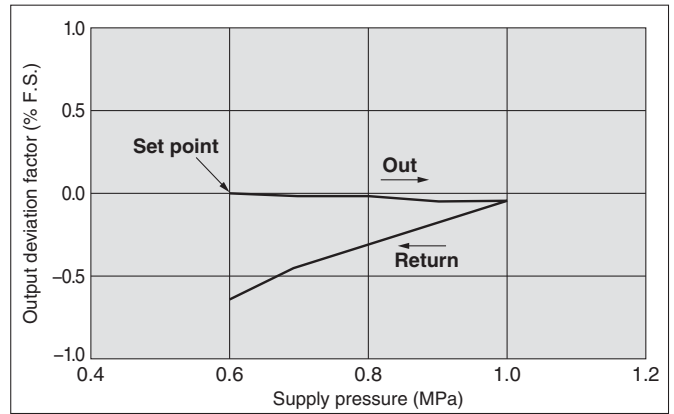

Flow-rate Characteristics

Supply pressure: 1.0 MPa

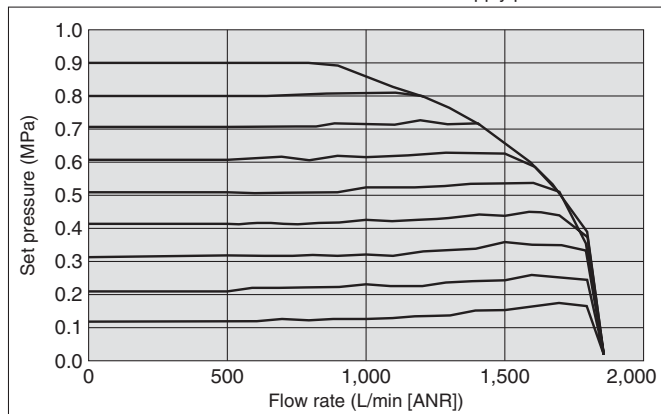

Series ITVX2000

Dimensions

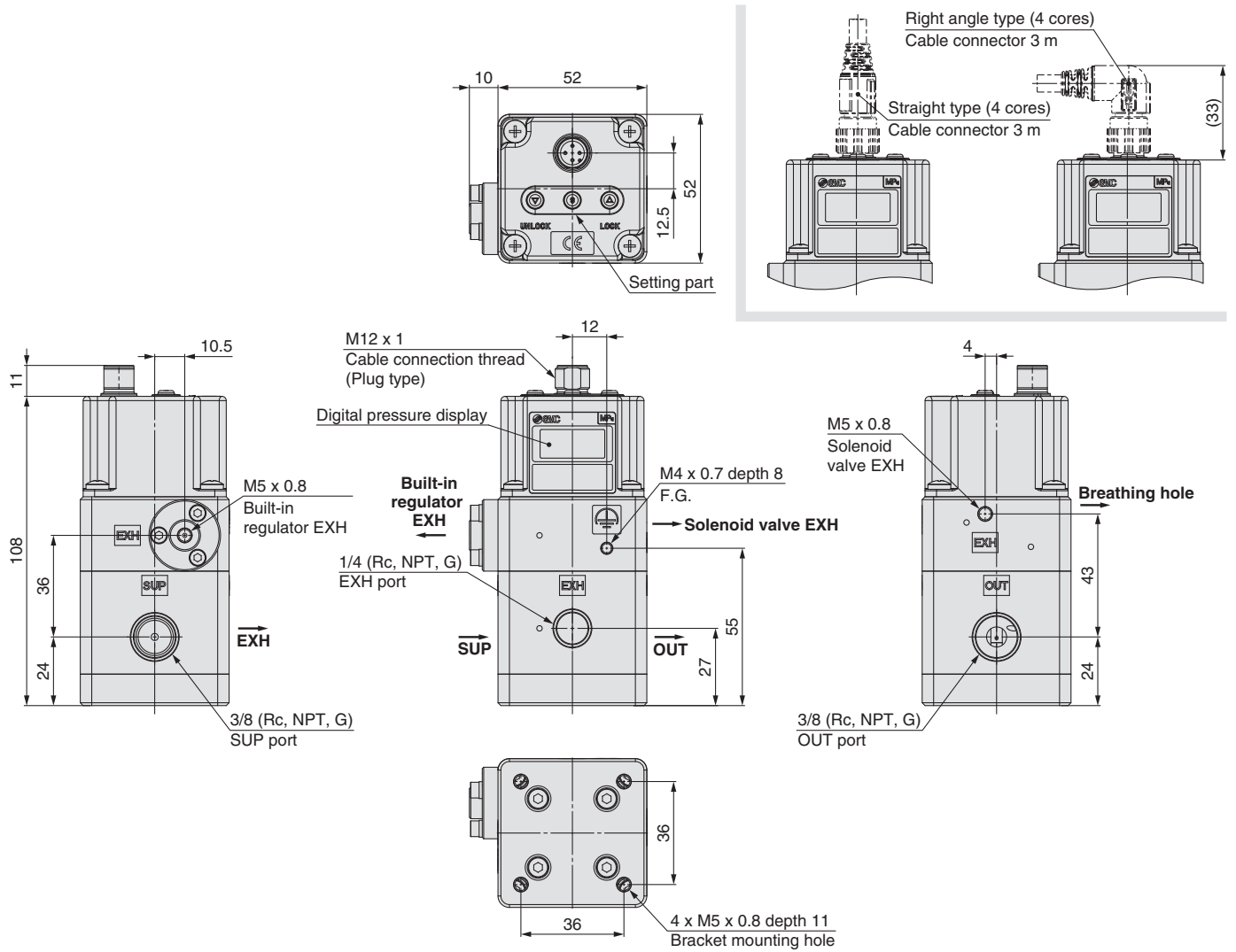

With flat bracket

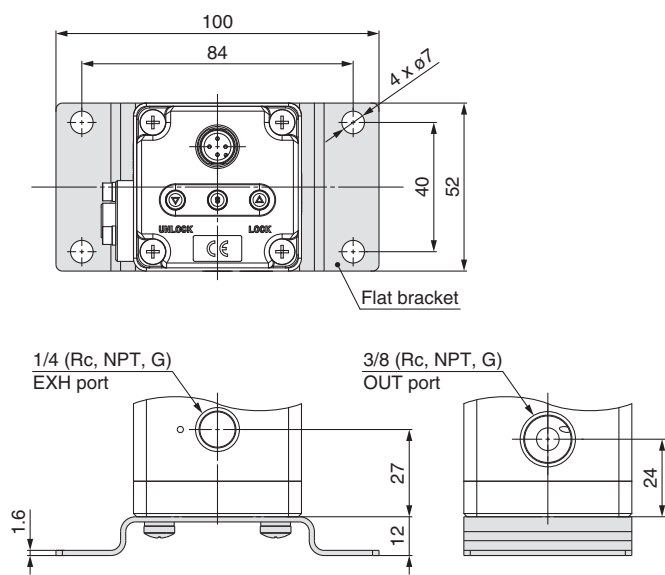

With L-bracket

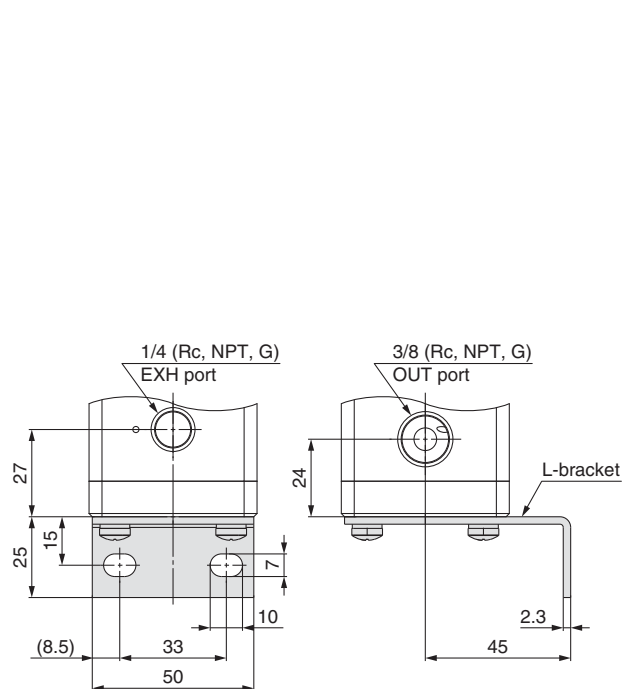



Series ITVX2000

Specific Product Precautions 1

Be sure to read before handling. Refer to back cover for Safety Instructions, "Handling Precaution for SMC Products" (M-E03-3) and the Operation Manual. Please download it via our website, <http://www.smcworld.com>

Piping

Warning

1. Screw piping together with the recommended proper torque while holding the side with the female threads.

Looseness or faulty sealing will occur if tightening torque is insufficient, while thread damage will result if the torque is excessive. Furthermore, if the side with the female threads is not held while tightening, excessive force will be applied directly to piping brackets etc., causing damage or other problems.

Connection thread	Recommended proper torque: N·m
M5	1.5 to 2
1/4	12 to 14
3/8	22 to 24

2. Do not allow twisting or bending moment to be applied other than the weight of the equipment.
Provide separate support for external piping, as damage may otherwise occur.
3. Since excessive moment loads and the propagation of vibrations, etc. can easily result from inflexible piping made of materials such as steel, avoid these problems by using flexible tubing for intermediate connections.

Caution

1. Preparation before piping

Before piping is connected, it should be thoroughly blown out with air (flushing) or washed to remove chips, cutting oil and other debris from inside the pipe.

2. Wrapping of pipe tape

When screwing together pipes and fittings, etc., be certain that chips from the pipe threads and sealing material do not get inside the piping.

Also, when pipe tape is used, leave 1.5 to 2 thread ridges exposed at the end of the threads.

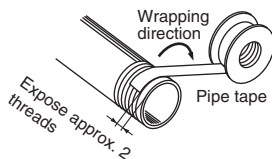

Operating Environment

Warning

1. Do not operate in locations having an atmosphere of corrosive gases, chemicals, sea water, or where there will be contact with the same.

Caution

1. In locations where the body is exposed to water, steam, dust, etc., there is a possibility that moisture or dust could enter the body through the EXH port, solenoid valve EXH port and/or built-in regulator EXH port, thereby causing problems.

Operating Environment

Caution

2. Do not operate in locations where vibration or impact occurs.
3. In locations which receive direct sunlight, provide a protective cover etc.
4. In locations near heat sources, block off any radiated heat.
5. Employ suitable protective measures in locations where there is contact with water droplets, oil or welding spatter, etc.

Fluid Supply

Warning

1. Compressed air, nitrogen, oxygen or argon can be used as a fluid.
2. Do not use compressed air which includes chemicals, synthetic oils containing organic solvents, salt, or corrosive gases, etc., as this can cause damage or malfunction.
3. If oxygen is used as the fluid, it can lead to serious and unforeseen risks. However, it is possible to manage and control the risk of hazards and economic loss. In order to use the product safely, it should only be handled by personnel with appropriate knowledge, with support from a suitably qualified specialist.
4. Oxygen gas increases the susceptibility of substances to burning; Oxygen gas can be ignited by frictional heat and static electricity. If oxygen is ignited, the metal and seal materials burn. Therefore, flush the piping thoroughly and mount a suitable filter to prevent foreign matter such as metal powder and dust from entering the product.
5. Take safety measures by installing safety devices (e.g. a circuit that stops the supply of oxygen gas) to prevent fire and explosion in the event of failure, taking flameproof safety standards into consideration.
6. Since there are three exhaust ports on the product, connect the piping in order to exhaust oxygen. Do not block the exhaust port.

Caution

1. This product does not have a filtering function. Install an air filter on the supply side close to the product. Select an air filter with a filtration degree of 5 µm or finer.
2. Compressed air containing large amounts of drainage can cause a malfunction of this product and other pneumatic equipment. As a countermeasure, install an aftercooler, air dryer or water droplet separator, etc.
3. If large amounts of carbon dust are generated by the compressor, it can accumulate inside this product and cause a malfunction.

For details on the above compressed air quality, refer to Best Pneumatics No. 5 "Air Preparation Equipment Model Selection Guide."



Series ITVX2000

Specific Product Precautions 2

Be sure to read before handling. Refer to back cover for Safety Instructions, "Handling Precaution for SMC Products" (M-E03-3) and the Operation Manual. Please download it via our website, <http://www.smcworld.com>

Handling

⚠ Caution

1. Do not use a lubricator on the supply side of this product, as this can cause a malfunction.
2. If electric power is shut off due to a power failure or any reason while the product is being controlled, air supply at the set pressure will be continuously consumed.
3. If supply pressure to this product is interrupted while the power is still on, the internal solenoid valve will continue to operate and a humming noise may be generated. Since the life of the product may be shortened, shut off the power supply also when supply pressure is shut off.
4. Do not block three EXH ports on this product.
5. This product does not have a shut-off valve function. If air pressure is supplied without electric power being applied, output pressure may increase to the pressure equivalent of the supply pressure. Due to product construction, a very small amount of air is discharged from the exhaust port when output pressure is generated. Operate the system to shut off the supply pressure when not operating the product.
6. The product is adjusted to each specification at the time of shipment from the factory. Do not perform unnecessary disassembly or removal of parts as it will cause failure.
7. The optional cable connector is a 4-core wire type. When the monitor output (analog output or switch output) is not being used, keep it from touching the other wires as this can cause a malfunction.
8. Please note that the right angle cable does not rotate and is limited to only one entry direction.
9. Take the following steps to avoid a malfunction due to noise.
 - 1) Remove power supply noise during operation by installing a line filter, etc. in the AC power line.
 - 2) For avoiding the influence of noise or static electricity, install this product and its wiring as far as possible from strong electric fields such as those of motors and power lines, etc.
 - 3) Be sure to implement protective measures against load surge for induction loads (solenoid valves, relays, etc.).
10. For details on the handling of this product, refer to the operation manual which is included with the product.

Design/Selection

⚠ Caution

1. The direct-current power supply to combine should be UL authorized power supply.

- 1) Limited voltage current circuit in accordance with UL508.
A circuit in which power is supplied by the secondary coil of a transformer that meets the following conditions.
 - Maximum voltage (with no load):
30 [Vrms] (42.4 [V peak]) or less
 - Maximum current:
 1. 8 [A] or less (including when short circuited)
 2. Limited by circuit protector (such as fuse) with the following ratings

No load voltage [V peak]	Max. current rating [A]
0 to 20 [V]	5.0
Over 20 [V] to 30 [V]	$\frac{100}{\text{Peak voltage}}$

- 2) A circuit using max. 30 [Vrms] or less (42.4 [V peak]), which is powered by UL1310 or UL1585 compatible Class-2 power supply.

2. Operate these products only within the specified voltage.

Using voltages beyond the specified levels could cause faults or malfunctions.

3. Use 0 V as the baseline for the power supplied to this product for output, control and input.

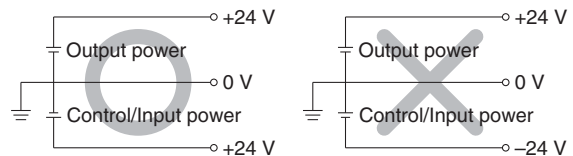

4. Each product needs to be powered by one power supply unit.

The wiring of this product has the same common between the GND for power and the signals; there is a possibility that a wrong current occurs and prevents a proper operation if one power supply unit controls multiple electro-pneumatic regulators.



Series ITVX2000

Specific Product Precautions 3

Be sure to read before handling. Refer to back cover for Safety Instructions, "Handling Precaution for SMC Products" (M-E03-3) and the Operation Manual. Please download it via our website, <http://www.smcworld.com>

Wiring

Caution

Connect the cable to the connector on the body with the wiring arranged as shown below. Proceed carefully, as incorrect wiring can cause damage. Further, use DC power with sufficient capacity and a low ripple.

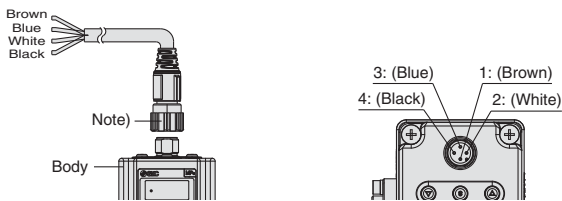

Note) The cable is also available in a right angle type. A right angle type connector is attached facing left (toward the SUP port). Do not attempt to rotate, as the connector does not turn.

Current Signal Type Voltage Signal Type

1	Brown	Power supply
2	White	Input signal
3	Blue	GND (COMMON)
4	Black	Monitor output

Wiring diagram

Current signal type

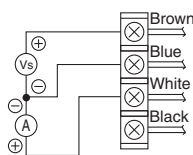

Vs : Power supply 24 VDC
A : Input signal 4 to 20 mA DC

Voltage signal type

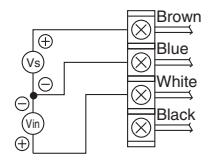

Vs : Power supply 24 VDC
Vin: Input signal 0 to 5 VDC

F.G. (Grounding)

Ground the frame ground (F.G.) terminal at the front of the main body. If the F.G. terminal port is not used, this product may not operate properly due to the noise.

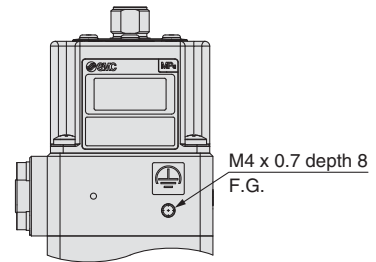

Monitor output wiring diagram

Analog output: Voltage type

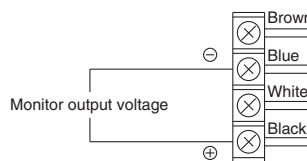

Analog output: Current type (Sink type)

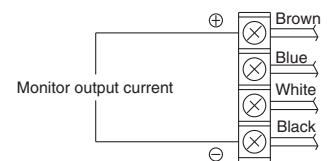

Switch output: NPN type

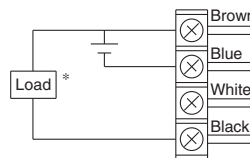

Switch output: PNP type

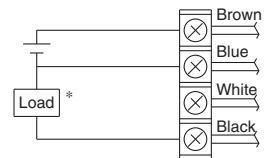



*When 80 mA DC or more is applied, detecting device for overcurrent starts activating and then emits an error signal. (Error number "5")

Safety Instructions

These safety instructions are intended to prevent hazardous situations and/or equipment damage. These instructions indicate the level of potential hazard with the labels of “**Caution**,” “**Warning**” or “**Danger**.” They are all important notes for safety and must be followed in addition to International Standards (ISO/IEC)*1, and other safety regulations.

 **Caution:** **Caution** indicates a hazard with a low level of risk which, if not avoided, could result in minor or moderate injury.

 **Warning:** **Warning** indicates a hazard with a medium level of risk which, if not avoided, could result in death or serious injury.

 **Danger:** **Danger** indicates a hazard with a high level of risk which, if not avoided, will result in death or serious injury.

*1) ISO 4414: Pneumatic fluid power – General rules relating to systems.
ISO 4413: Hydraulic fluid power – General rules relating to systems.
IEC 60204-1: Safety of machinery – Electrical equipment of machines.
(Part 1: General requirements)
ISO 10218-1: Manipulating industrial robots - Safety.
etc.

Warning

1. The compatibility of the product is the responsibility of the person who designs the equipment or decides its specifications.

Since the product specified here is used under various operating conditions, its compatibility with specific equipment must be decided by the person who designs the equipment or decides its specifications based on necessary analysis and test results. The expected performance and safety assurance of the equipment will be the responsibility of the person who has determined its compatibility with the product. This person should also continuously review all specifications of the product referring to its latest catalog information, with a view to giving due consideration to any possibility of equipment failure when configuring the equipment.

2. Only personnel with appropriate training should operate machinery and equipment.

The product specified here may become unsafe if handled incorrectly. The assembly, operation and maintenance of machines or equipment including our products must be performed by an operator who is appropriately trained and experienced.

3. Do not service or attempt to remove product and machinery/equipment until safety is confirmed.

1. The inspection and maintenance of machinery/equipment should only be performed after measures to prevent falling or runaway of the driven objects have been confirmed.
2. When the product is to be removed, confirm that the safety measures as mentioned above are implemented and the power from any appropriate source is cut, and read and understand the specific product precautions of all relevant products carefully.
3. Before machinery/equipment is restarted, take measures to prevent unexpected operation and malfunction.

4. Contact SMC beforehand and take special consideration of safety measures if the product is to be used in any of the following conditions.

1. Conditions and environments outside of the given specifications, or use outdoors or in a place exposed to direct sunlight.
2. Installation on equipment in conjunction with atomic energy, railways, air navigation, space, shipping, vehicles, military, medical treatment, combustion and recreation, or equipment in contact with food and beverages, emergency stop circuits, clutch and brake circuits in press applications, safety equipment or other applications unsuitable for the standard specifications described in the product catalog.
3. An application which could have negative effects on people, property, or animals requiring special safety analysis.
4. Use in an interlock circuit, which requires the provision of double interlock for possible failure by using a mechanical protective function, and periodical checks to confirm proper operation.

Caution

1. The product is provided for use in manufacturing industries.

The product herein described is basically provided for peaceful use in manufacturing industries.

If considering using the product in other industries, consult SMC beforehand and exchange specifications or a contract if necessary.
If anything is unclear, contact your nearest sales branch.

Limited warranty and Disclaimer/ Compliance Requirements

The product used is subject to the following “Limited warranty and Disclaimer” and “Compliance Requirements”.

Read and accept them before using the product.

Limited warranty and Disclaimer

1. The warranty period of the product is 1 year in service or 1.5 years after the product is delivered.*2)

Also, the product may have specified durability, running distance or replacement parts. Please consult your nearest sales branch.

2. For any failure or damage reported within the warranty period which is clearly our responsibility, a replacement product or necessary parts will be provided.

This limited warranty applies only to our product independently, and not to any other damage incurred due to the failure of the product.

3. Prior to using SMC products, please read and understand the warranty terms and disclaimers noted in the specified catalog for the particular products.

*2) **Vacuum pads are excluded from this 1 year warranty.**

A vacuum pad is a consumable part, so it is warranted for a year after it is delivered.

Also, even within the warranty period, the wear of a product due to the use of the vacuum pad or failure due to the deterioration of rubber material are not covered by the limited warranty.

Compliance Requirements

1. The use of SMC products with production equipment for the manufacture of weapons of mass destruction (WMD) or any other weapon is strictly prohibited.

2. The exports of SMC products or technology from one country to another are governed by the relevant security laws and regulations of the countries involved in the transaction. Prior to the shipment of a SMC product to another country, assure that all local rules governing that export are known and followed.

 **Safety Instructions** Be sure to read “Handling Precautions for SMC Products” (M-E03-3) before using.

SMC Corporation

Akihabara UDX 15F,
4-14-1, Sotokanda, Chiyoda-ku, Tokyo 101-0021, JAPAN
Phone: 03-5207-8249 Fax: 03-5298-5362
<http://www.smcworld.com>
© 2012 SMC Corporation All Rights Reserved

Specifications are subject to change without prior notice and any obligation on the part of the manufacturer.

D-DN

1st printing QT printing QT 8100SZ Printed in Japan.